

General Description

The AOD409 uses advanced trench technology to provide excellent $R_{DS(ON)}$, low gate charge and low gate resistance. With the excellent thermal resistance of the TO-252 package, this device is well suited for high current load applications.

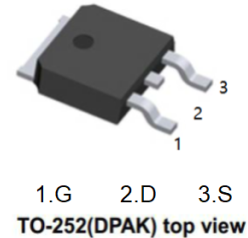

Features

- V_{DS} (V) = -60V
- I_D = -26A (V_{GS} = -10V)
- $R_{DS(ON)}$ < 48m Ω (V_{GS} = -10V) @ -20A
- $R_{DS(ON)}$ < 55m Ω (V_{GS} = -4.5V)

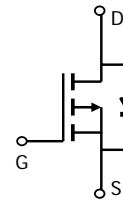

Absolute Maximum Ratings $T_A = 25^\circ\text{C}$ unless otherwise noted

Parameter	Symbol	Maximum	Units		
Drain-Source Voltage	V_{DS}	-60	V		
Gate-Source Voltage	V_{GS}	± 20	V		
Continuous Drain Current ^G	I_D	$T_C = 25^\circ\text{C}$	A		
		$T_C = 100^\circ\text{C}$			
Pulsed Drain Current ^C	I_{DM}	-60			
Avalanche Current ^C	I_{AR}	-26	A		
Repetitive avalanche energy $L = 0.1\text{mH}$ ^C	E_{AR}	33.8	mJ		
Power Dissipation ^B	P_D	$T_C = 25^\circ\text{C}$	W		
		$T_C = 100^\circ\text{C}$			
Power Dissipation ^A	P_{DSM}	$T_A = 25^\circ\text{C}$	W		
		$T_A = 70^\circ\text{C}$			
Junction and Storage Temperature Range	T_J, T_{STG}	-55 to 175	$^\circ\text{C}$		
Thermal Characteristics					
Parameter	Symbol	Typ	Max	Units	
Maximum Junction-to-Ambient ^A	$R_{\theta JA}$	$t \leq 10\text{s}$	16.7	25	$^\circ\text{C/W}$
Maximum Junction-to-Ambient ^A		Steady-State	40	50	$^\circ\text{C/W}$
Maximum Junction-to-Case ^C	$R_{\theta JC}$	1.9	2.5	$^\circ\text{C/W}$	

Electrical Characteristics (T_J=25°C unless otherwise noted)

Symbol	Parameter	Conditions	Min	Typ	Max	Units
STATIC PARAMETERS						
BV _{DSS}	Drain-Source Breakdown Voltage	I _D =-250μA, V _{GS} =0V	-60			V
I _{DSS}	Zero Gate Voltage Drain Current	V _{DS} =-48V, V _{GS} =0V T _J =55°C		-0.003	-1	μA
I _{GSS}	Gate-Body leakage current	V _{DS} =0V, V _{GS} =±20V			±100	nA
V _{GS(th)}	Gate Threshold Voltage	V _{DS} =V _{GS} , I _D =-250μA	-1.2	-1.9	-2.4	V
I _{D(ON)}	On state drain current	V _{GS} =-10V, V _{DS} =-5V	-60			A
R _{DS(ON)}	Static Drain-Source On-Resistance	V _{GS} =-10V, I _D =-20A		32	48	mΩ
		V _{GS} =-4.5V, I _D =-20A		43	55	mΩ
g _{FS}	Forward Transconductance	V _{DS} =-5V, I _D =-20A		32		S
V _{SD}	Diode Forward Voltage	I _S =-1A, V _{GS} =0V		-0.73	-1	V
I _S	Maximum Body-Diode Continuous Current				-30	A
DYNAMIC PARAMETERS						
C _{iss}	Input Capacitance	V _{GS} =0V, V _{DS} =-30V, f=1MHz		2977	3600	pF
C _{oss}	Output Capacitance			241		pF
C _{riss}	Reverse Transfer Capacitance			153		pF
R _g	Gate resistance	V _{GS} =0V, V _{DS} =0V, f=1MHz		2	2.4	Ω
SWITCHING PARAMETERS						
Q _{g(10V)}	Total Gate Charge	V _{GS} =-10V, V _{DS} =-30V, I _D =-20A		44	54	nC
Q _{g(4.5V)}	Total Gate Charge			22.2	28	nC
Q _{gs}	Gate Source Charge			9		nC
Q _{gd}	Gate Drain Charge			10		nC
t _{D(on)}	Turn-On DelayTime	V _{GS} =-10V, V _{DS} =-30V, R _L =1.5Ω, R _{GEN} =3Ω		12		ns
t _r	Turn-On Rise Time			14.5		ns
t _{D(off)}	Turn-Off DelayTime			38		ns
t _f	Turn-Off Fall Time			15		ns
t _{rr}	Body Diode Reverse Recovery Time		I _F =-20A, dI/dt=100A/μs		40	50
Q _{rr}	Body Diode Reverse Recovery Charge	I _F =-20A, dI/dt=100A/μs		59		nC

A: The value of R_{qJA} is measured with the device mounted on 1in 2 FR-4 board with 2oz. Copper, in a still air environment with T_A=25°C. The Power dissipation PDSM is based on R_{qJA} and the maximum allowed junction temperature of 150°C. The value in any a given application depends on the user's specific board design, and the maximum temperature fo 175°C may be used if the PCB allows it.

B: The power dissipation PD is based on T_{J(MAX)}=175°C, using junction-to-case thermal resistance, and is more useful in setting the upper dissipation limit for cases where additional heatsinking is used.

C: Repetitive rating, pulse width limited by junction temperature T_{J(MAX)}=175°C.

D: The R_{qJA} is the sum of the thermal impedance from junction to case R_{qJC} and case to ambient.

E: The static characteristics in Figures 1 to 6 are obtained using <300 ms pulses, duty cycle 0.5% max.

F: These curves are based on the junction-to-case thermal impedance which is measured with the device mounted to a large heatsink, assuming a maximum junction temperature of T_{J(MAX)}=175°C.

G: The maximum current rating is limited by bond-wires.

H: These tests are performed with the device mounted on 1 in 2 FR-4 board with 2oz. Copper, in a still air environment with T_A=25°C. The SOA curve provides a single pulse rating.

TYPICAL ELECTRICAL AND THERMAL CHARACTERISTICS

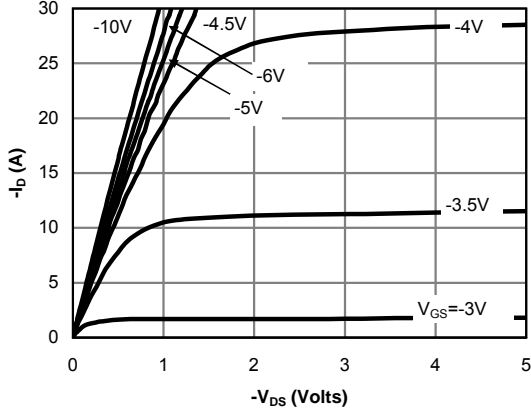

Fig 1: On-Region Characteristics

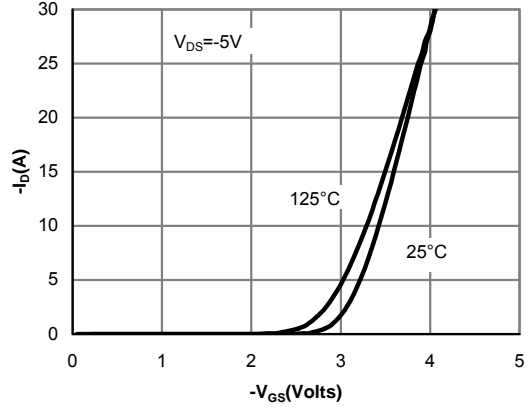

Figure 2: Transfer Characteristics

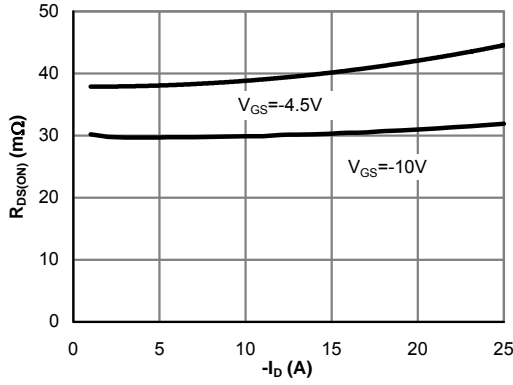

Figure 3: On-Resistance vs. Drain Current and Gate Voltage

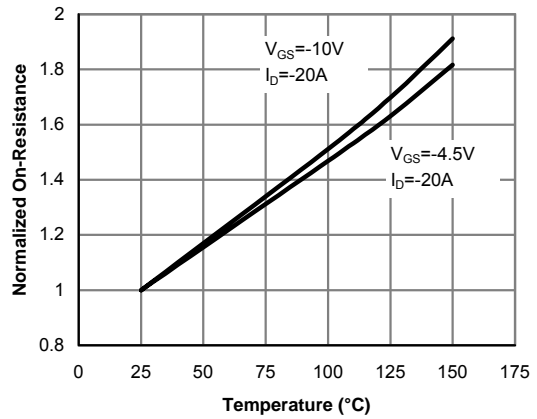

Figure 4: On-Resistance vs. Junction Temperature

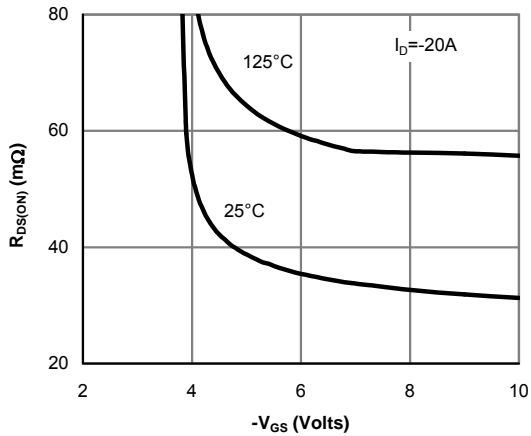

Figure 5: On-Resistance vs. Gate-Source Voltage

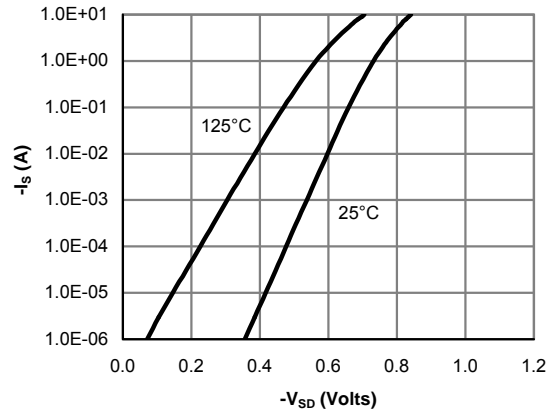

Figure 6: Body-Diode Characteristics

TYPICAL ELECTRICAL AND THERMAL CHARACTERISTICS

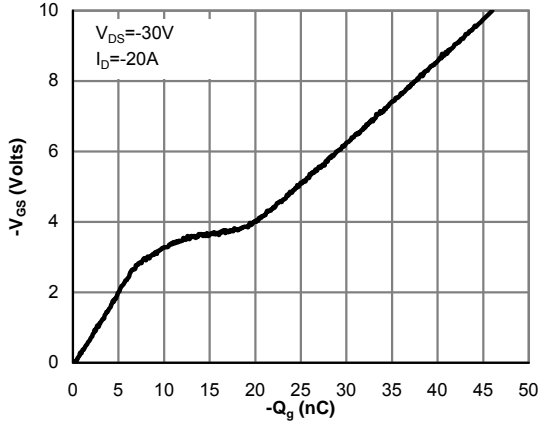

Figure 7: Gate-Charge Characteristics

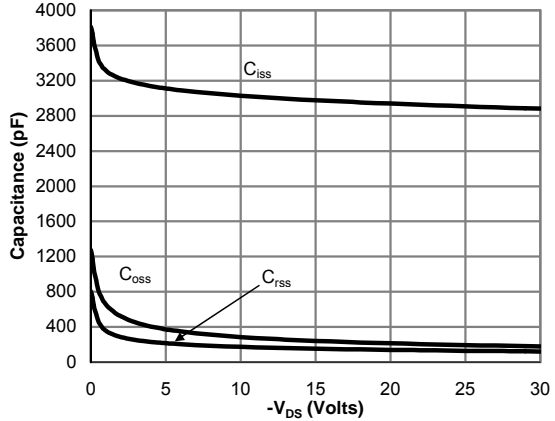

Figure 8: Capacitance Characteristics

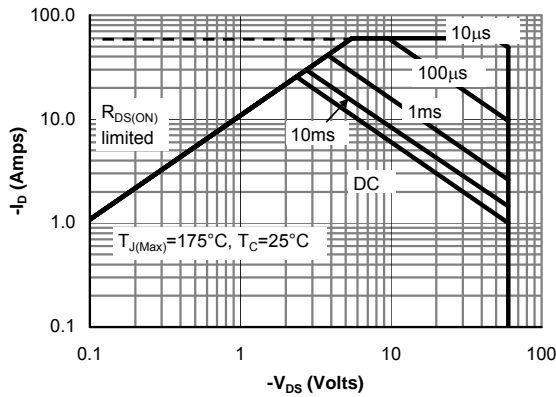

Figure 9: Maximum Forward Biased Safe Operating Area (Note F)

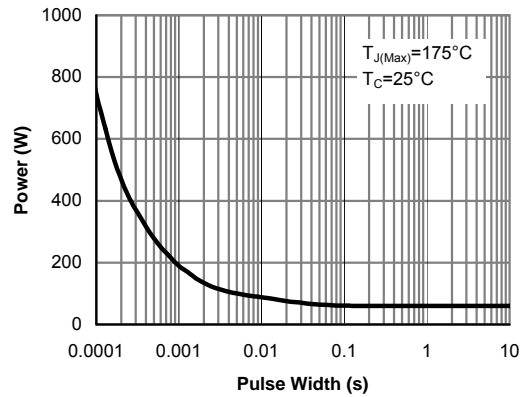

Figure 10: Single Pulse Power Rating Junction-to-Case (Note F)

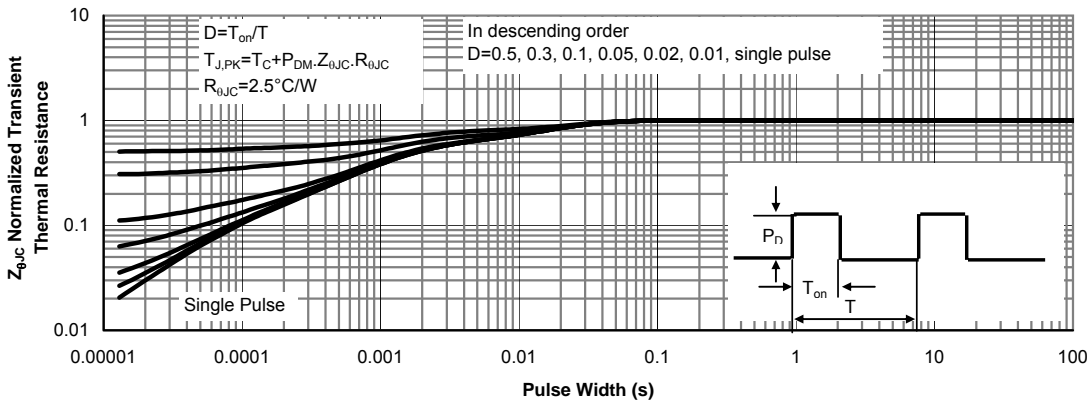

Figure 11: Normalized Maximum Transient Thermal Impedance (Note F)

TYPICAL ELECTRICAL AND THERMAL CHARACTERISTICS

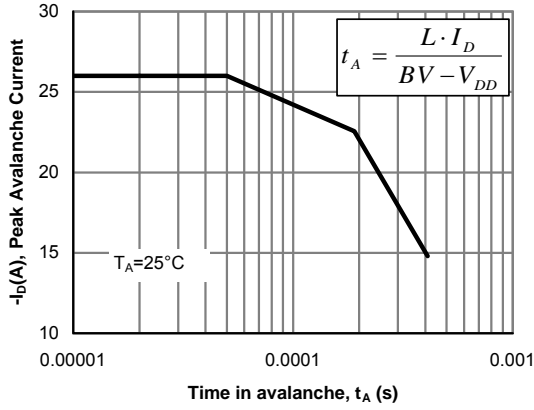

Figure 12: Single Pulse Avalanche capability

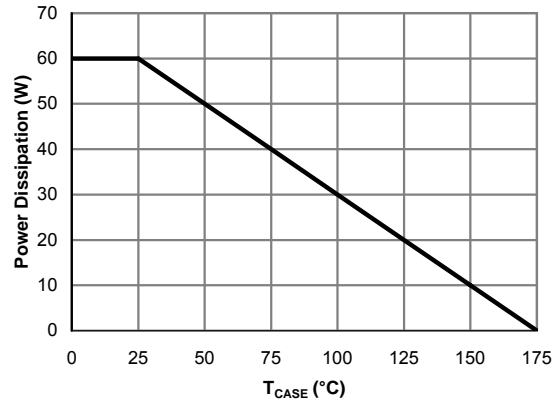

Figure 13: Power De-rating (Note B)

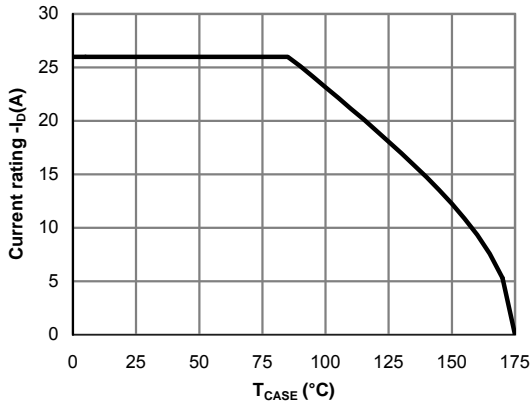

Figure 14: Current De-rating (Note B)

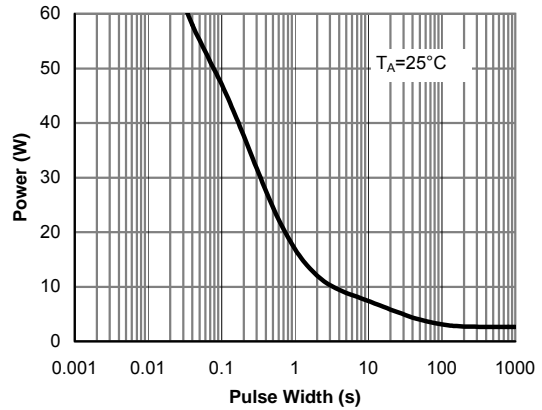

Figure 15: Single Pulse Power Rating Junction-to-Ambient (Note H)

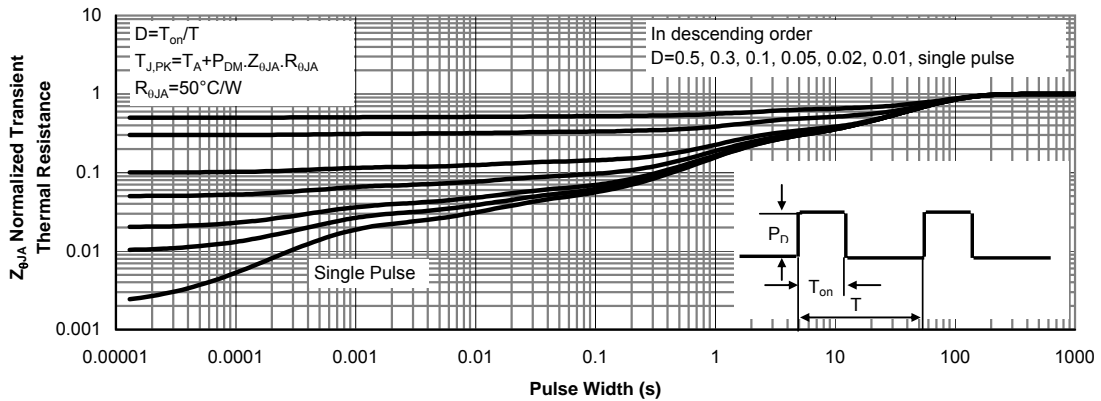
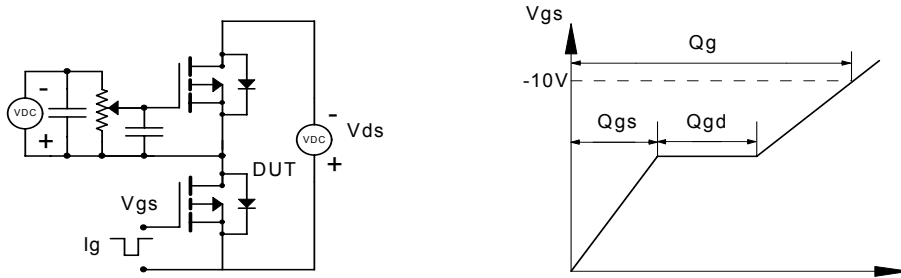
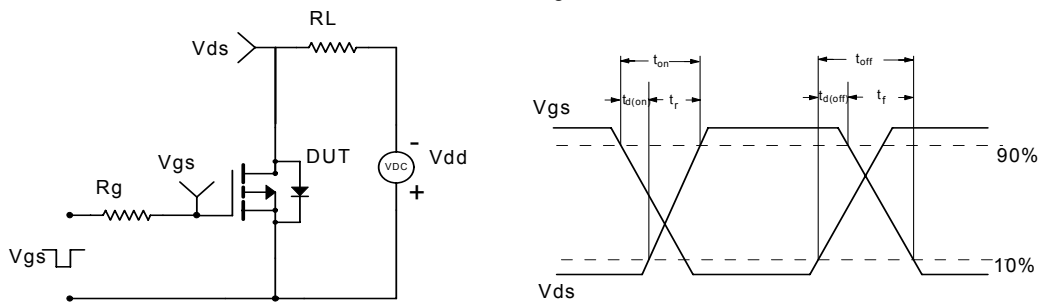

Figure 16: Normalized Maximum Transient Thermal Impedance (Note H)

Gate Charge Test Circuit & Waveform



Resistive Switching Test Circuit & Waveforms



Unclamped Inductive Switching (UIS) Test Circuit & Waveforms

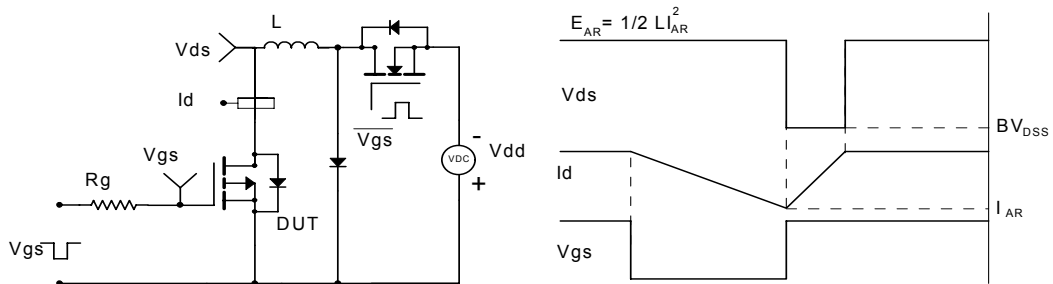

Diode Recovery Test Circuit & Waveforms

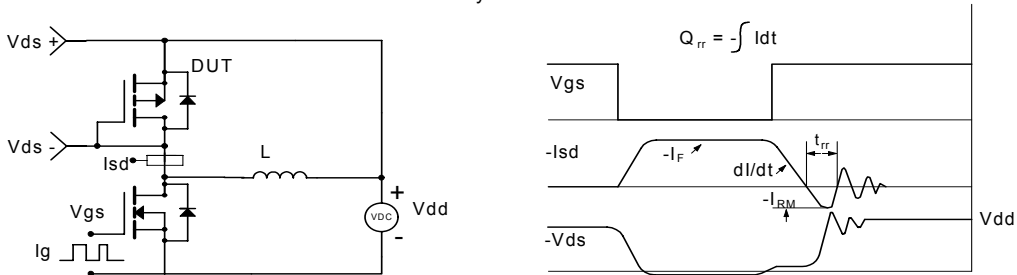

Package Mechanical Data TO-252

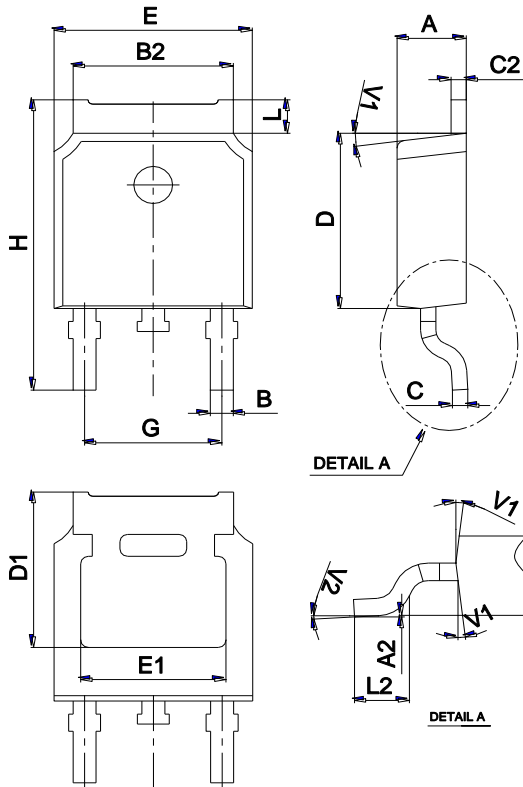

Ref.	Dimensions					
	Millimeters			Inches		
	Min.	Typ.	Max.	Min.	Typ.	Max.
A	2.10		2.50	0.083		0.098
A2	0		0.10	0		0.004
B	0.66		0.86	0.026		0.034
B2	5.18		5.48	0.202		0.216
C	0.40		0.60	0.016		0.024
C2	0.44		0.58	0.017		0.023
D	5.90		6.30	0.232		0.248
D1	5.30REF			0.209REF		
E	6.40		6.80	0.252		0.268
E1	4.63			0.182		
G	4.47		4.67	0.176		0.184
H	9.50		10.70	0.374		0.421
L	1.09		1.21	0.043		0.048
L2	1.35		1.65	0.053		0.065
V1		7°			7°	
V2	0°		6°	0°		6°

Marking

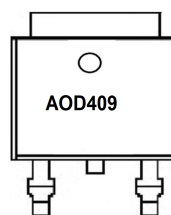

Ordering information

Order code	Package	Baseqty	Deliverymode
AOD409	TO-252	2500	Tape and reel