

Applications

- Power management
- Load switch
- Battery protection

Features

- $V_{DS} (V) = -20V$
- $R_{DS(ON)} < 100m\Omega$ ($V_{GS} = -4.5V$)
- $R_{DS(ON)} < 120m\Omega$ ($V_{GS} = -2.5V$)

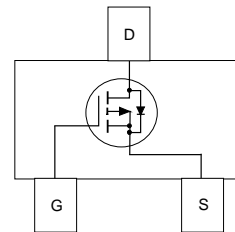
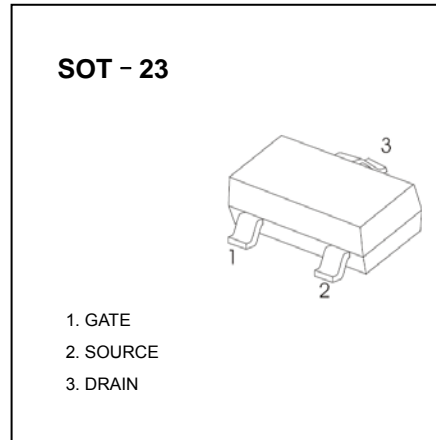

Absolute Maximum Ratings $T_A=25^\circ C$ unless otherwise noted

Symbol	Parameter	Ratings	Units
V_{DSS}	Drain-Source Voltage	-20	V
V_{GSS}	Gate-Source Voltage	± 12	V
I_D	Drain Current – Continuous (Note 1a) – Pulsed	-1.5	A
		-10	
P_D	Maximum Power Dissipation (Note 1a) (Note 1b)	0.5	W
		0.46	
T_J, T_{STG}	Operating and Storage Junction Temperature Range	-55 to +150	$^\circ C$

Thermal Characteristics

$R_{\theta JA}$	Thermal Resistance, Junction-to-Ambient (Note 1a)	250	$^\circ C/W$
$R_{\theta JC}$	Thermal Resistance, Junction-to-Case (Note 1)	75	$^\circ C/W$

Electrical Characteristics

T_A = 25°C unless otherwise noted

Symbol	Parameter	Test Conditions	Min	Typ	Max	Units
--------	-----------	-----------------	-----	-----	-----	-------

Off Characteristics

BV _{DSS}	Drain–Source Breakdown Voltage	V _{GS} = 0 V, I _D = –250 μA	–20			V
$\frac{\Delta BV_{DSS}}{\Delta T_J}$	Breakdown Voltage Temperature Coefficient	I _D = –250 μA, Referenced to 25°C		–13		mV/°C
I _{DSS}	Zero Gate Voltage Drain Current	V _{DS} = –16 V, V _{GS} = 0 V			–1	μA
I _{GSSF}	Gate–Body Leakage, Forward	V _{GS} = 12 V, V _{DS} = 0 V			100	nA
I _{GSSR}	Gate–Body Leakage, Reverse	V _{GS} = –12 V, V _{DS} = 0 V			–100	nA

On Characteristics (Note 2)

V _{GS(th)}	Gate Threshold Voltage	V _{DS} = V _{GS} , I _D = –250 μA	–0.6	–1.0	–1.5	V
$\frac{\Delta V_{GS(th)}}{\Delta T_J}$	Gate Threshold Voltage Temperature Coefficient	I _D = –250 μA, Referenced to 25°C		3		mV/°C
R _{DS(on)}	Static Drain–Source On–Resistance	V _{GS} = –4.5 V, I _D = –1.5 A V _{GS} = –2.5 V, I _D = –1.3 A		86 110	100 120	mΩ
I _{D(on)}	On–State Drain Current	V _{GS} = –4.5 V, V _{DS} = –5 V	–5			A
g _{FS}	Forward Transconductance	V _{DS} = –5 V, I _D = –1.5 A		12		S

Dynamic Characteristics

C _{iss}	Input Capacitance	V _{DS} = –10 V, V _{GS} = 0 V, f = 1.0 MHz		341		pF
C _{oss}	Output Capacitance			83		pF
C _{rss}	Reverse Transfer Capacitance			43		pF
t _{d(on)}	Turn–On Delay Time	V _{DD} = –10 V, I _D = –1 A, V _{GS} = –4.5 V, R _{GEN} = 6 Ω		8	16	ns
t _r	Turn–On Rise Time			10	20	ns
t _{d(off)}	Turn–Off Delay Time			12	22	ns
t _f	Turn–Off Fall Time			8	16	ns
Q _g	Total Gate Charge	V _{DS} = –10V, I _D = –1.5 A, V _{GS} = –4.5 V		3.8	5.4	nC
Q _{gs}	Gate–Source Charge			0.8		nC
Q _{gd}	Gate–Drain Charge			1.0		nC

Drain–Source Diode Characteristics and Maximum Ratings

I _S	Maximum Continuous Drain–Source Diode Forward Current			–0.42		A
V _{SD}	Drain–Source Diode Forward Voltage	V _{GS} = 0 V, I _S = –0.42 (Note 2)		–0.7	–1.2	V

Notes:

- R_{θJA} is the sum of the junction-to-case and case-to-ambient thermal resistance where the case thermal reference is defined as the solder mounting surface of the drain pins. R_{θJC} is guaranteed by design while R_{θCA} is determined by the user's board design.



a) 250°C/W when mounted on a 0.02 in² pad of 2 oz. copper.



b) 270°C/W when mounted on a minimum pad.

Scale 1 : 1 on letter size paper

- Pulse Test: Pulse Width ≤ 300 μs, Duty Cycle ≤ 2.0%

Typical Characteristics

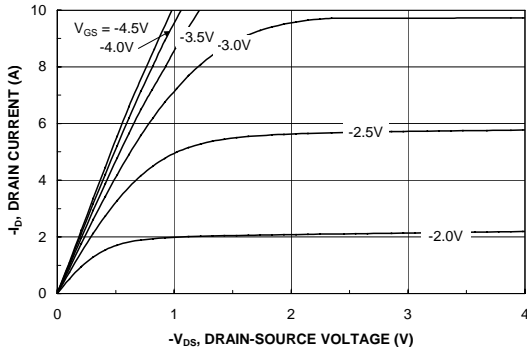

Figure 1. On-Region Characteristics.

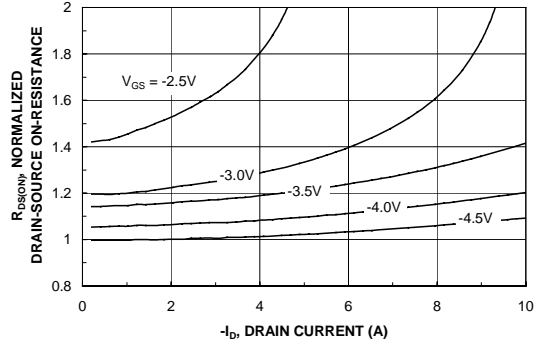

Figure 2. On-Resistance Variation with Drain Current and Gate Voltage.

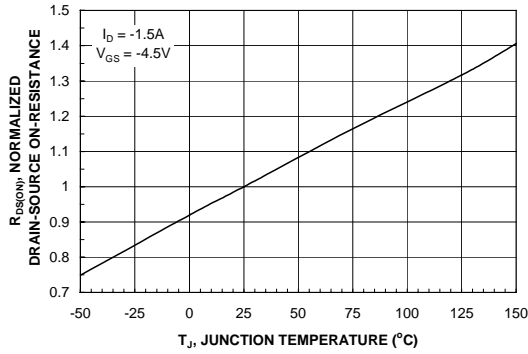

Figure 3. On-Resistance Variation with Temperature.

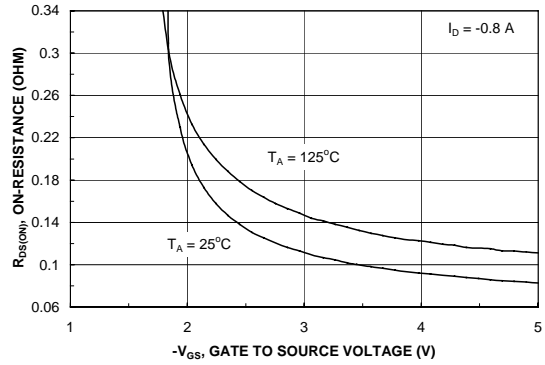

Figure 4. On-Resistance Variation with Gate-to-Source Voltage.

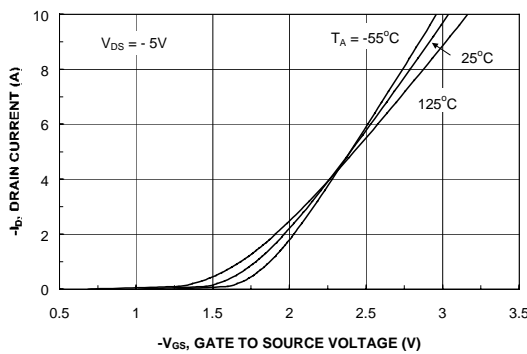

Figure 5. Transfer Characteristics.

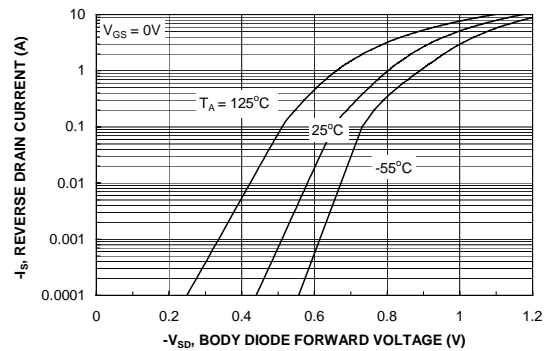

Figure 6. Body Diode Forward Voltage Variation with Source Current and Temperature.

Typical Characteristics

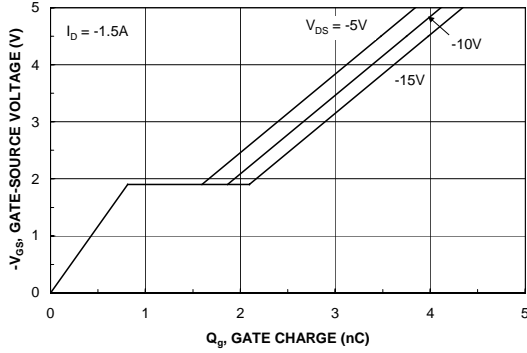

Figure 7. Gate Charge Characteristics.

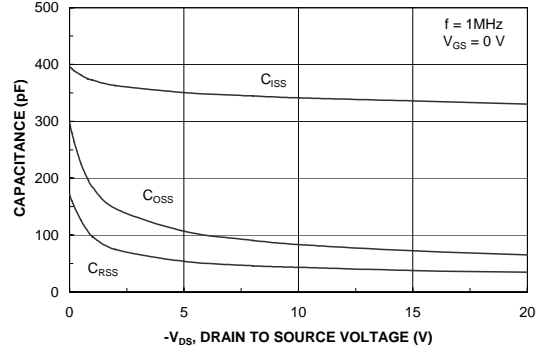

Figure 8. Capacitance Characteristics.

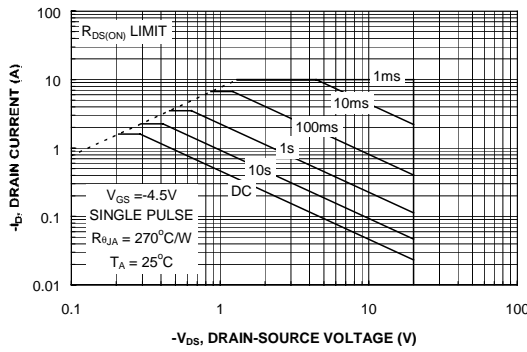

Figure 9. Maximum Safe Operating Area.

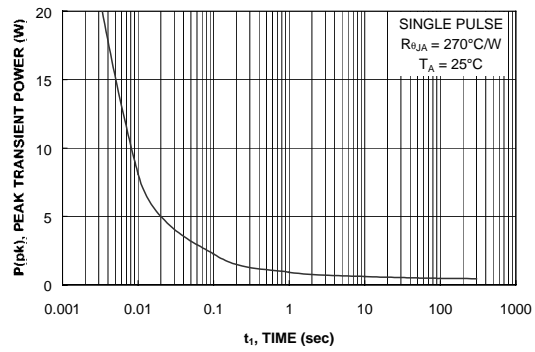

Figure 10. Single Pulse Maximum Power Dissipation.

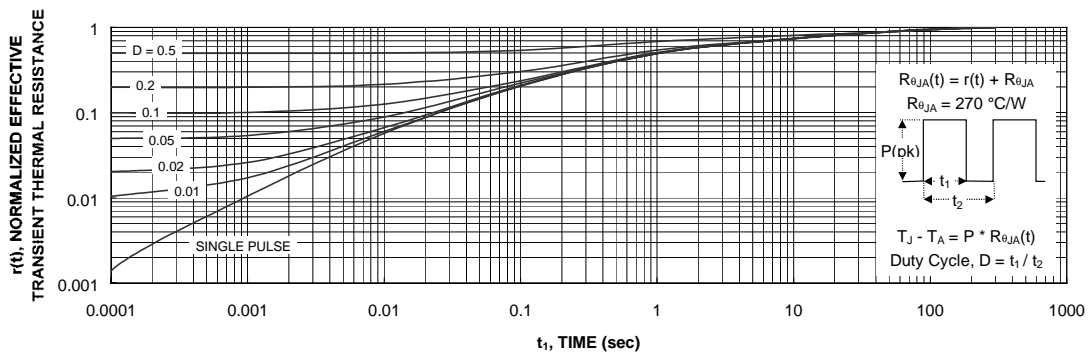
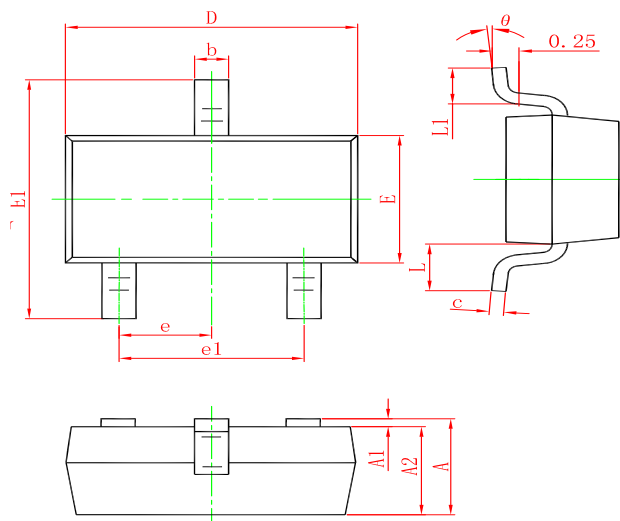

Figure 11. Transient Thermal Response Curve.

Thermal characterization performed using the conditions described in Note 1b. Transient thermal response will change depending on the circuit board design.

SOT-23 PACKAGE OUTLINE DIMENSIONS



Symbol	Dimensions In Millimeters		Dimensions In Inches	
	Min.	Max.	Min.	Max.
A	0.900	1.150	0.035	0.045
A1	0.000	0.100	0.000	0.004
A2	0.900	1.050	0.035	0.041
b	0.300	0.500	0.012	0.020
c	0.080	0.150	0.003	0.006
D	2.800	3.000	0.110	0.118
E	1.200	1.400	0.047	0.055
E1	2.250	2.550	0.089	0.100
e	0.950 TYP.		0.037 TYP.	
e1	1.800	2.000	0.071	0.079
L	0.550 REF.		0.022 REF.	
L1	0.300	0.500	0.012	0.020
theta	0°	8°	0°	8°

Marking

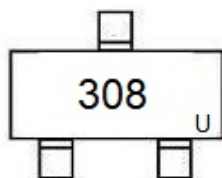

Ordering information

Order code	Package	Baseqty	Deliverymode
FDN308P	SOT-23	3000	Tape and reel