

FDN337N

N-Channel MOSFET

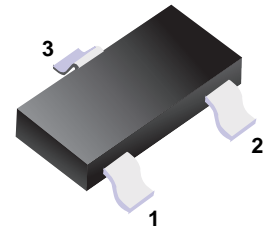

- 1. Gate
- 2. Source
- 3. Drain

■ Features

- $V_{DS} (V) = 30 V$
- $I_D = 2.2 A$
- $R_{DS(ON)} = 0.065 \Omega @ V_{GS} = 4.5 V$
- $R_{DS(ON)} = 0.082 \Omega @ V_{GS} = 2.5 V$

■ Simplified outline(SOT-23)

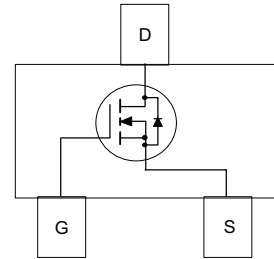

■ Absolute Maximum Ratings $T_A = 25^\circ C$ unless otherwise noted

Parameter	Symbol	Rating	Unit	
Drain-Source Voltage	V_{DS}	30	V	
Gate-Source Voltage	V_{GS}	± 8		
Continuous Drain Current	I_D	2.2	A	
Pulsed Drain Current	I_{DM}	10		
Power Dissipation	P_D	(Note 1a)	0.5	W
		(Note 1b)	0.46	
Thermal Resistance.Junction- to-Ambient	R_{thJA}	250	$^\circ C/W$	
Thermal Resistance.Junction- to-Case	R_{thJC}	75		
Junction Temperature	T_J	150	$^\circ C$	
Storage Temperature Range	T_{stg}	-55 to 150		

Notes:

1. $R_{\theta JA}$ is the sum of the junction-to-case and case-to-ambient thermal resistance where the case thermal reference is defined as the solder mounting surface of the drain pins. $R_{\theta JC}$ is guaranteed by design while $R_{\theta CA}$ is determined by the user's board design.

a. $250^\circ C/W$ when mounted on a 0.02 in^2 pad of 2oz Cu.

c. $270^\circ C/W$ when mounted on a 0.001 in^2 pad of 2oz Cu.

■ Electrical Characteristics $T_A = 25^\circ\text{C}$ unless otherwise noted

Parameter	Symbol	Test Conditions	Min	Typ	Max	Unit
Drain-Source Breakdown Voltage	V_{DS}	$I_D=250\ \mu\text{A}, V_{GS}=0\text{V}$	30			V
Zero Gate Voltage Drain Current	I_{DSS}	$V_{DS}=24\text{V}, V_{GS}=0\text{V}$			1	μA
		$V_{DS}=24\text{V}, V_{GS}=0\text{V}, T_J=55^\circ\text{C}$			10	
Gate-Body Leakage Current	I_{GSS}	$V_{DS}=0\text{V}, V_{GS}=\pm 8\text{V}$			± 100	nA
Gate Threshold Voltage	$V_{GS(th)}$	$V_{DS}=V_{GS}, I_D=250\ \mu\text{A}$	0.4		1	V
Static Drain-Source On-Resistance	$R_{DS(on)}$	$V_{GS}=4.5\text{V}, I_D=2.2\ \text{A}$			65	m Ω
		$V_{GS}=4.5\text{V}, I_D=2.2\ \text{A}, T_J=125^\circ\text{C}$			110	
		$V_{GS}=2.5\text{V}, I_D=2\ \text{A}$			82	
On State Drain Current	$I_{D(ON)}$	$V_{GS}=4.5\ \text{V}, V_{DS}=5\ \text{V}$	10			A
Forward Transconductance	g_{FS}	$V_{DS}=5\ \text{V}, I_D=2.2\ \text{A}$		13		S
Input Capacitance	C_{iss}	$V_{GS}=0\text{V}, V_{DS}=10\ \text{V}, f=1\text{MHz}$		300		pF
Output Capacitance	C_{oss}			145		
Reverse Transfer Capacitance	C_{rss}			35		
Total Gate Charge	Q_g	$V_{GS}=4.5\ \text{V}, V_{DS}=10\ \text{V}, I_D=2.2\ \text{A}$		7	9	nC
Gate Source Charge	Q_{gs}			1.1		
Gate Drain Charge	Q_{gd}			1.9		
Turn-On DelayTime	$t_{d(on)}$	$V_{GS}=4.5\ \text{V}, V_{DD}=5\ \text{V}, I_D=1\ \text{A}, R_{GEN}=6\ \Omega$		4	10	ns
Turn-On Rise Time	t_r			10	18	
Turn-Off DelayTime	$t_{d(off)}$			17	28	
Turn-Off Fall Time	t_f			4	10	
Maximum Body-Diode Continuous Current	I_S				0.42	A
Diode Forward Voltage	V_{SD}	$I_S=0.42\ \text{A}, V_{GS}=0\text{V}$ (Note 2)			1.2	V

Note 2: Pulse Test: Pulse Width $\leq 300\ \mu\text{s}$, Duty Cycle $\leq 2.0\%$

■ Typical Characteristics

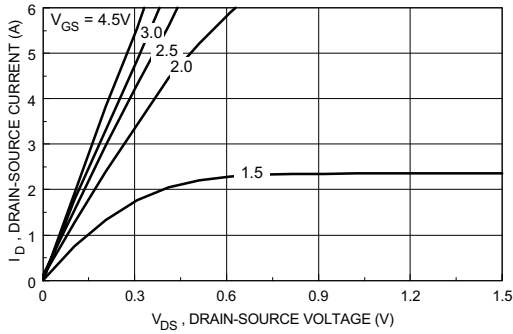

Figure 1. On-Region Characteristics.

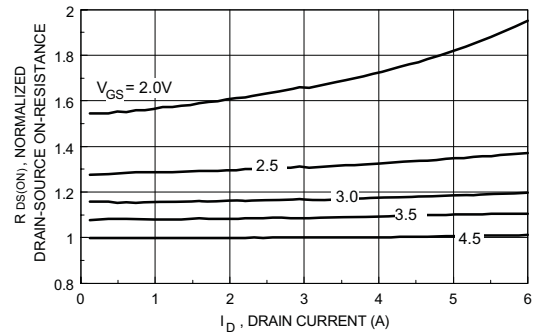

Figure 2. On-Resistance Variation with Drain Current and Gate

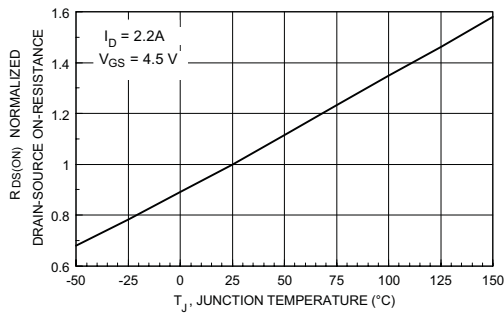

Figure 3. On-Resistance Variation with Temperature.

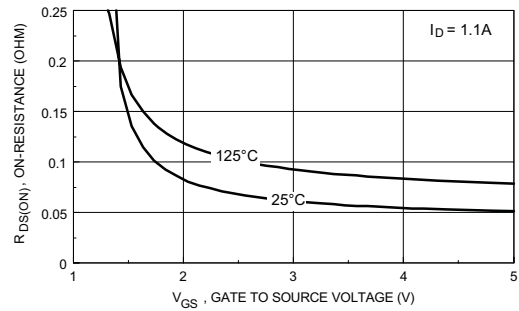

Figure 4. On-Resistance Variation with Gate-to-Source Voltage.

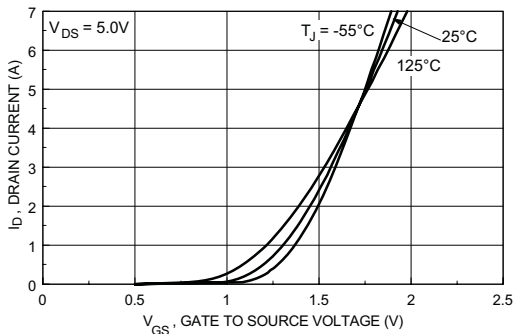

Figure 5. Transfer Characteristics.

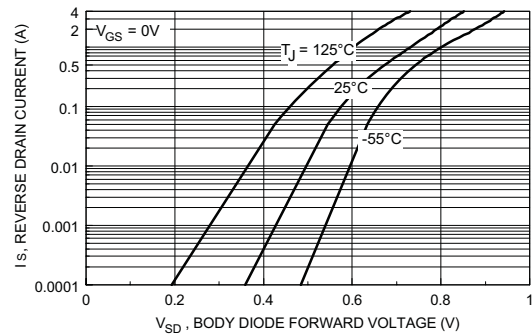

Figure 6. Body Diode Forward Voltage Variation with Source Current and Temperature.

■ Typical Characteristics

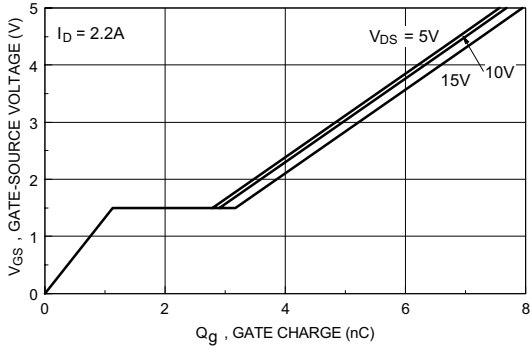

Figure 7. Gate Charge Characteristics.

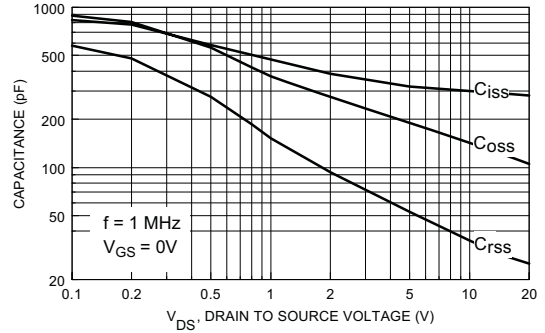

Figure 8. Capacitance Characteristics.

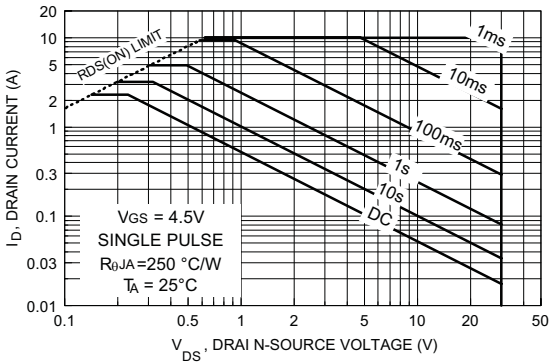

Figure 9. Maximum Safe Operating Area.

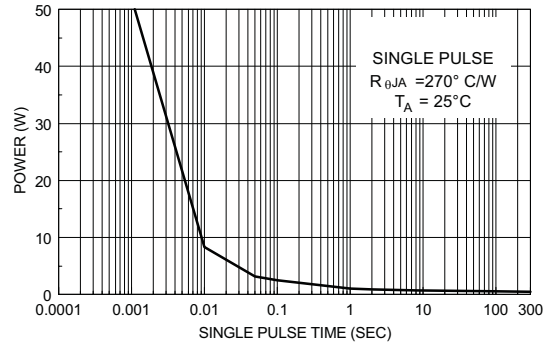

Figure 10. Single Pulse Maximum Power Dissipation.

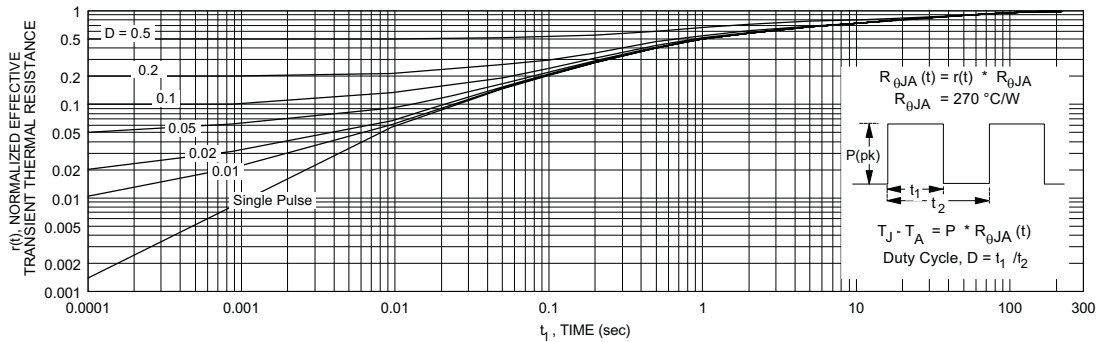
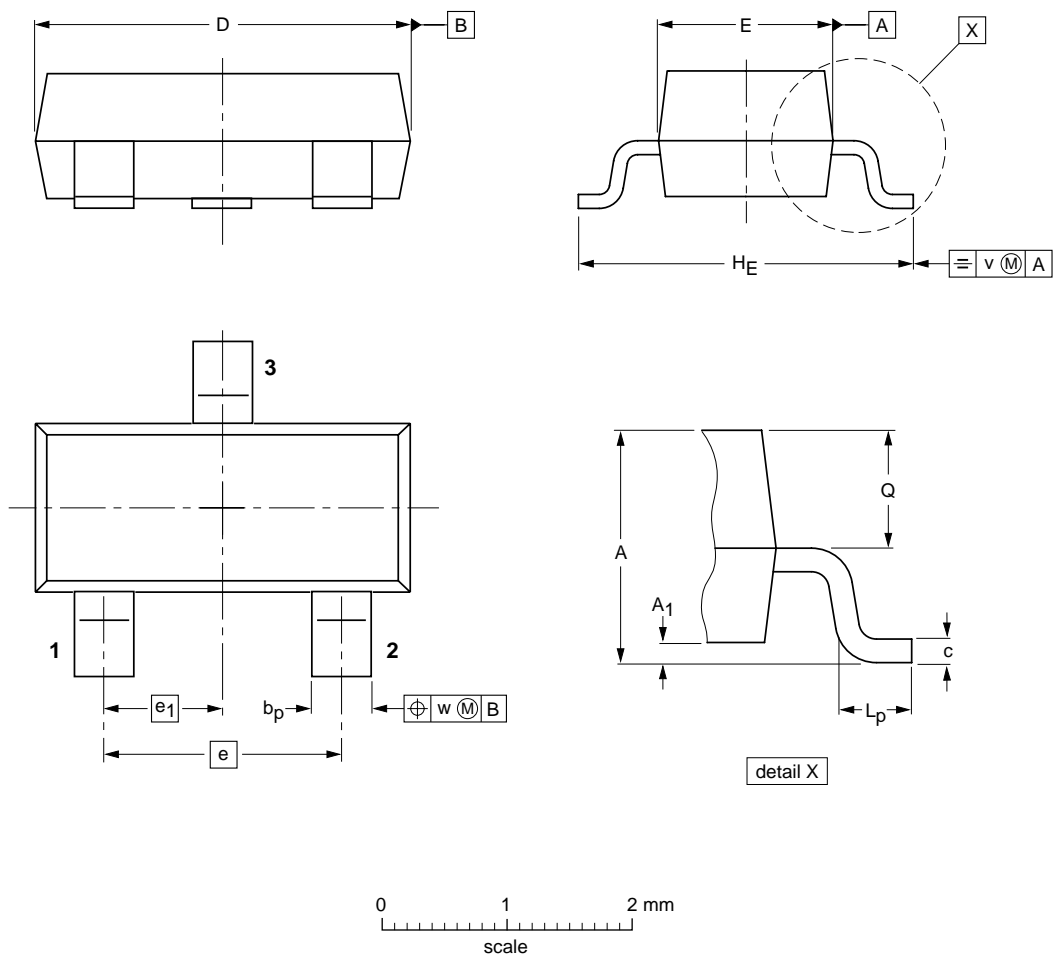

Figure 11. Transient Thermal Response Curve.

Thermal characterization performed using the conditions described in note 1b.
Transient thermal response will change depending on the circuit board design.

■ SOT-23



DIMENSIONS (mm are the original dimensions)

UNIT	A	A ₁ max.	b _p	c	D	E	e	e ₁	H _E	L _p	Q	v	w
mm	1.1 0.9	0.1	0.48 0.38	0.15 0.09	3.0 2.8	1.4 1.2	1.9	0.95	2.5 2.1	0.45 0.15	0.55 0.45	0.2	0.1