

PRODUCT SUMMARY

- $V_{DS} (V) = -30V$
- $R_{DS(ON)} < 43m\Omega$ ($V_{GS} = -4.5V$)
- $R_{DS(ON)} < 52m\Omega$ ($V_{GS} = -2.5V$)

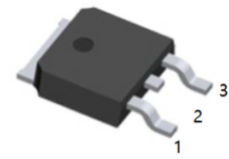

1.G 2.D 3.S
TO-252(DPAK) top view

FEATURES

- Halogen-free

APPLICATIONS

- Load Switch
- Notebook Adaptor Switch

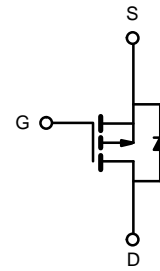

P-Channel MOSFET

ABSOLUTE MAXIMUM RATINGS $T_A = 25\text{ }^\circ\text{C}$, unless otherwise noted

Parameter	Symbol	Limit	Unit	
Drain-Source Voltage	V_{DS}	- 30	V	
Gate-Source Voltage	V_{GS}	± 20		
Continuous Drain Current ($T_J = 150\text{ }^\circ\text{C}$)	I_D	$T_C = 25\text{ }^\circ\text{C}$	- 26	
		$T_C = 70\text{ }^\circ\text{C}$	- 21	
		$T_A = 25\text{ }^\circ\text{C}$	- 12.9 ^{a, b}	
		$T_A = 70\text{ }^\circ\text{C}$	- 9.6 ^{a, b}	
Pulsed Drain Current	I_{DM}	- 112	A	
Continuous Source-Drain Diode Current	I_S	$T_C = 25\text{ }^\circ\text{C}$		- 4.1
		$T_A = 25\text{ }^\circ\text{C}$		- 2.2 ^{a, b}
Avalanche Current	I_{AS}	- 20	mJ	
Single-Pulse Avalanche Energy	E_{AS}	20		
Maximum Power Dissipation	P_D	$T_C = 25\text{ }^\circ\text{C}$	25	
		$T_C = 70\text{ }^\circ\text{C}$	20	
		$T_A = 25\text{ }^\circ\text{C}$	2.7 ^{a, b}	
		$T_A = 70\text{ }^\circ\text{C}$	1.7 ^{a, b}	
Operating Junction and Storage Temperature Range	T_J, T_{stg}	- 55 to 150	$^\circ\text{C}$	

THERMAL RESISTANCE RATINGS

Parameter	Symbol	Typical	Maximum	Unit
Maximum Junction-to-Ambient ^{a, c}	R_{thJA}	38	46	$^\circ\text{C/W}$
Maximum Junction-to-Foot	R_{thJF}	20	25	

Notes:

- a. Surface mounted on 1" x 1" FR4 board.
- b. $t = 10\text{ s}$.
- c. Maximum under Steady State conditions is 85 $^\circ\text{C/W}$.
- d. Based on $T_C = 25\text{ }^\circ\text{C}$.

SPECIFICATIONS $T_J = 25\text{ }^\circ\text{C}$, unless otherwise noted

Parameter	Symbol	Test Conditions	Min.	Typ.	Max.	Unit
Static						
Drain-Source Breakdown Voltage	V_{DS}	$V_{GS} = 0\text{ V}, I_D = -250\text{ }\mu\text{A}$	-30			V
V_{DS} Temperature Coefficient	$\Delta V_{DS}/T_J$	$I_D = -250\text{ }\mu\text{A}$		-34		mV/ °C
$V_{GS(th)}$ Temperature Coefficient	$\Delta V_{GS(th)}/T_J$		5.3			
Gate-Source Threshold Voltage	$V_{GS(th)}$	$V_{DS} = V_{GS}, I_D = -250\text{ }\mu\text{A}$	-1.0		-2.5	V
Gate-Source Leakage	I_{GSS}	$V_{DS} = 0\text{ V}, V_{GS} = \pm 25\text{ V}$			± 100	nA
Zero Gate Voltage Drain Current	I_{DSS}	$V_{DS} = -30\text{ V}, V_{GS} = 0\text{ V}$			-1	μA
		$V_{DS} = -30\text{ V}, V_{GS} = 0\text{ V}, T_J = 55\text{ }^\circ\text{C}$			-5	
On-State Drain Current ^a	$I_{D(on)}$	$V_{DS} \geq -10\text{ V}, V_{GS} = -10\text{ V}$	-30			A
Drain-Source On-State Resistance ^a	$R_{DS(on)}$	$V_{GS} = -4.5\text{ V}, I_D = -10\text{ A}$		33	43	m Ω
		$V_{GS} = -2.5\text{ V}, I_D = -8\text{ A}$		46	52	
Forward Transconductance ^a	g_{fs}	$V_{DS} = -10\text{ V}, I_D = -10\text{ A}$		28		S
Dynamic^b						
Input Capacitance	C_{iss}	$V_{DS} = -15\text{ V}, V_{GS} = 0\text{ V}, f = 1\text{ MHz}$		1350		pF
Output Capacitance	C_{oss}		255			
Reverse Transfer Capacitance	C_{rss}		190			
Total Gate Charge	Q_g	$V_{DS} = -15\text{ V}, V_{GS} = -10\text{ V}, I_D = -10\text{ A}$		27	43	nC
				19	25	
Gate-Source Charge	Q_{gs}	$V_{DS} = -15\text{ V}, V_{GS} = -4.5\text{ V}, I_D = -10\text{ A}$		6		
Gate-Drain Charge	Q_{gd}			12		
Gate Resistance	R_g	$f = 1\text{ MHz}$	0.5	2.2	4.4	Ω
Turn-On Delay Time	$t_{d(on)}$	$V_{DD} = -15\text{ V}, R_L = 1.5\text{ }\Omega$ $I_D \cong -10\text{ A}, V_{GEN} = -10\text{ V}, R_g = 1\text{ }\Omega$		13	25	ns
Rise Time	t_r			12	24	
Turn-Off Delay Time	$t_{d(off)}$			40	70	
Fall Time	t_f			9	18	
Turn-On Delay Time	$t_{d(on)}$	$V_{DD} = -15\text{ V}, R_L = 1.5\text{ }\Omega$ $I_D \cong -10\text{ A}, V_{GEN} = -4.5\text{ V}, R_g = 1\text{ }\Omega$		48	80	
Rise Time	t_r			92	160	
Turn-Off Delay Time	$t_{d(off)}$			34	60	
Fall Time	t_f			19	35	
Drain-Source Body Diode Characteristics						
Continuous Source-Drain Diode Current	I_S	$T_C = 25\text{ }^\circ\text{C}$			-4.1	A
Pulse Diode Forward Current	I_{SM}				-60	
Body Diode Voltage	V_{SD}	$I_S = -3\text{ A}, V_{GS} = 0\text{ V}$		-0.75	-1.2	V
Body Diode Reverse Recovery Time	t_{rr}	$I_F = -10\text{ A}, dI/dt = 100\text{ A}/\mu\text{s}, T_J = 25\text{ }^\circ\text{C}$		27	45	ns
Body Diode Reverse Recovery Charge	Q_{rr}			16	27	nC
Reverse Recovery Fall Time	t_a			12		ns
Reverse Recovery Rise Time	t_b			15		

Notes:

- a. Pulse test; pulse width $\leq 300\text{ }\mu\text{s}$, duty cycle $\leq 2\%$.
b. Guaranteed by design, not subject to production testing.

TYPICAL CHARACTERISTICS 25 °C, unless otherwise noted

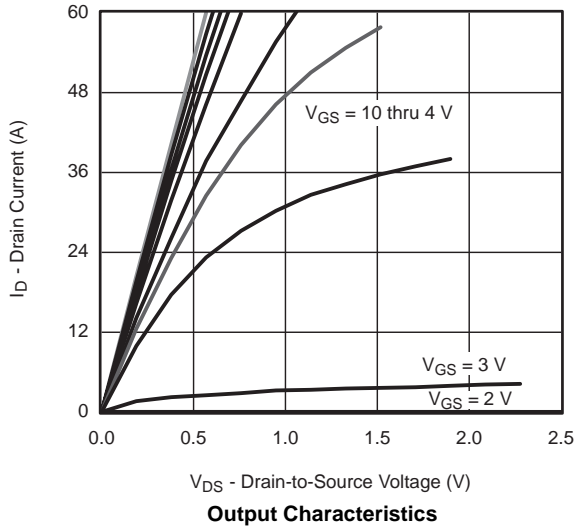

Output Characteristics

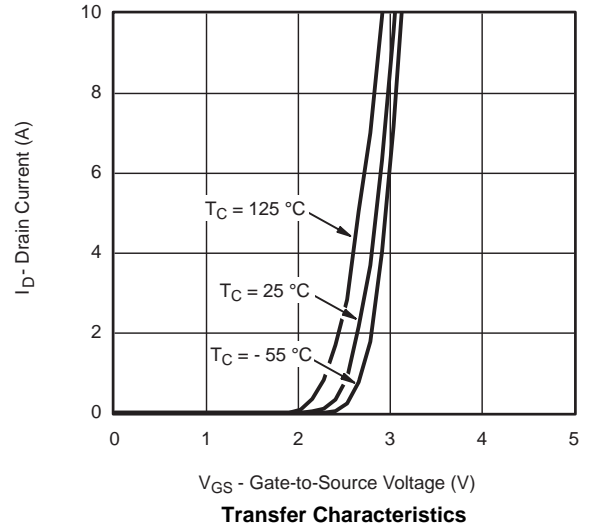

Transfer Characteristics

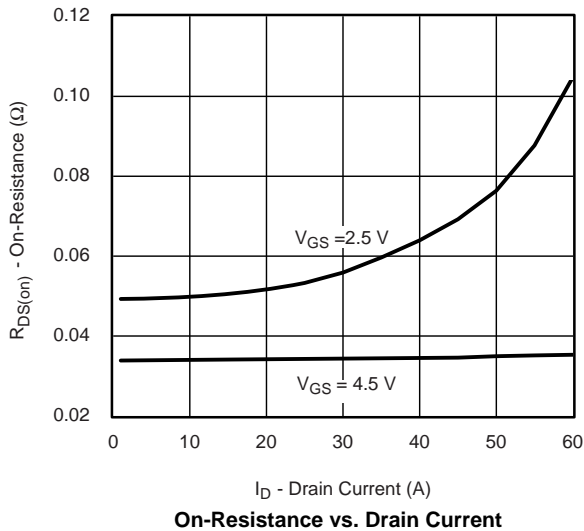

On-Resistance vs. Drain Current

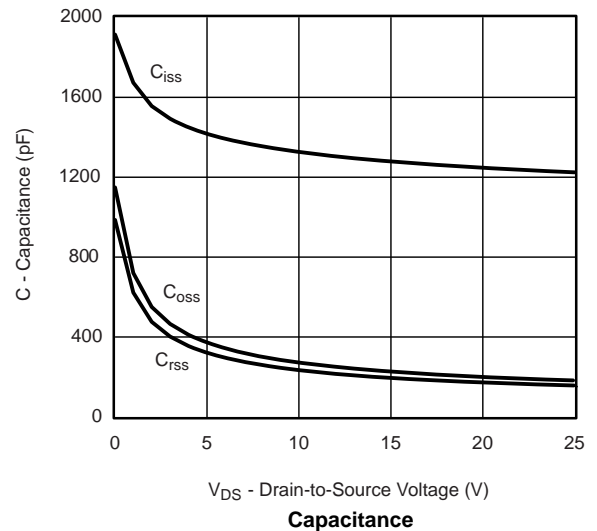

Capacitance

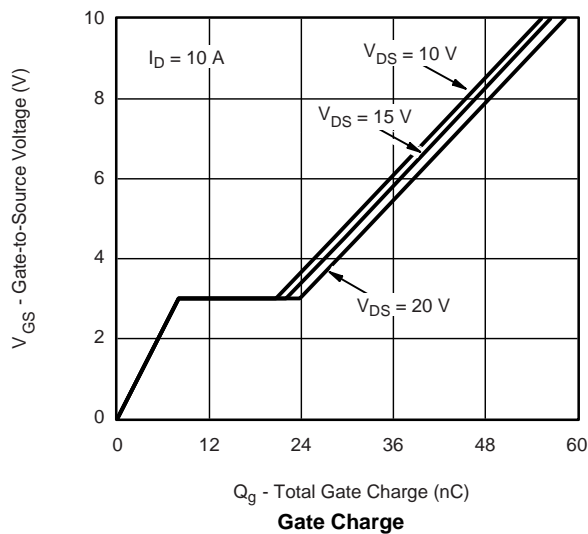

Gate Charge

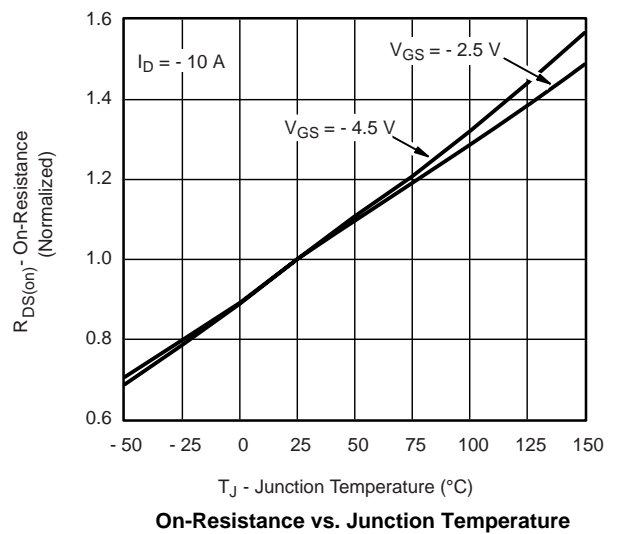

On-Resistance vs. Junction Temperature

TYPICAL CHARACTERISTICS 25 °C, unless otherwise noted

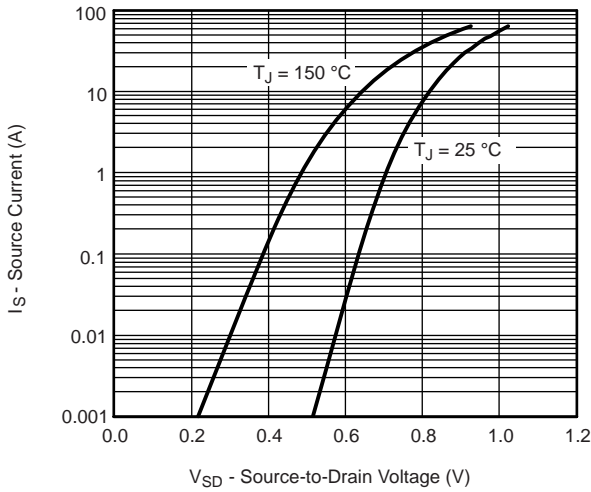

Source-Drain Diode Forward Voltage

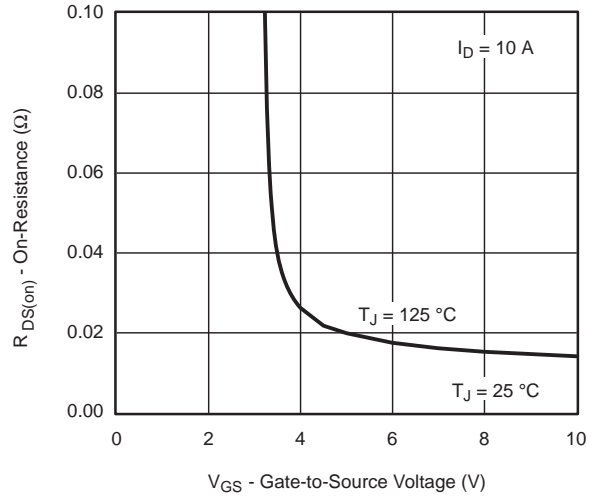

On-Resistance vs. Gate-to-Source Voltage

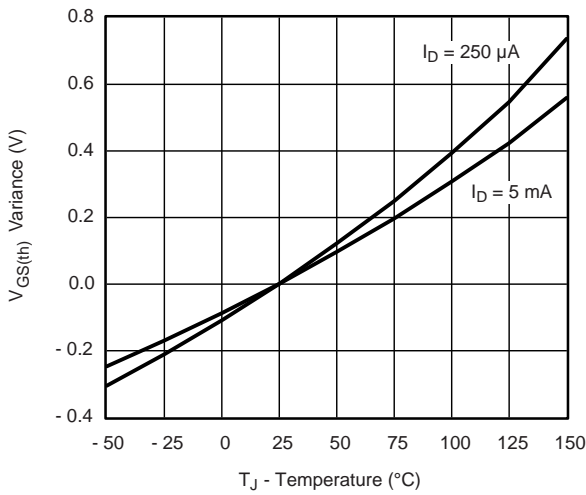

Threshold Voltage

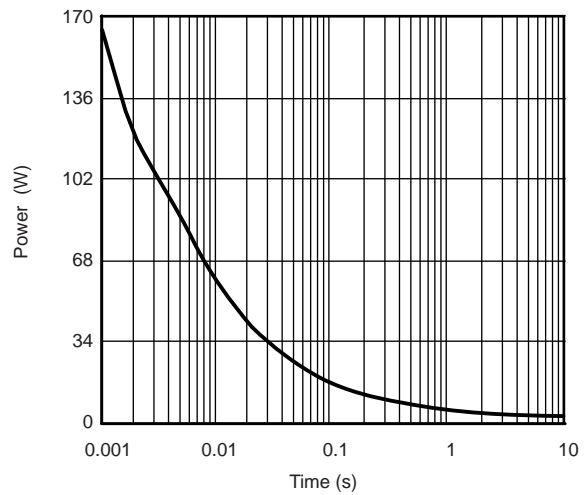

Single Pulse Power, Junction-to-Ambient

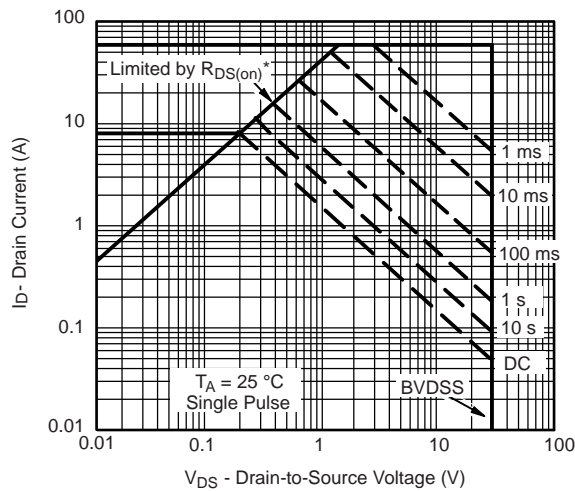

* $V_{GS} >$ minimum V_{GS} at which $R_{DS(on)}$ is specified

Safe Operating Area

MOSFET TYPICAL CHARACTERISTICS 25 °C, unless otherwise noted

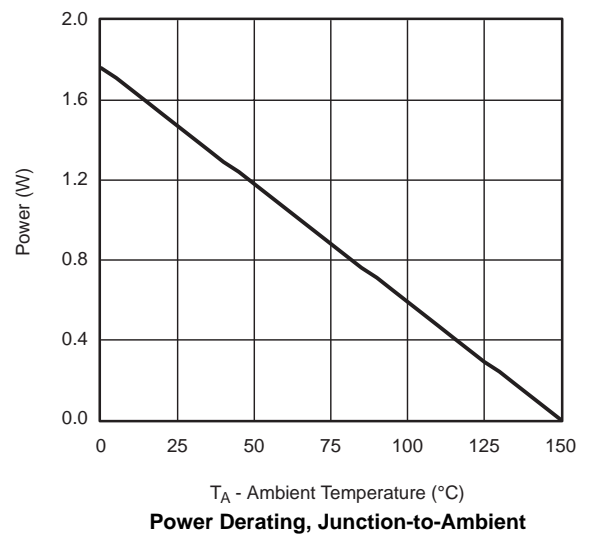
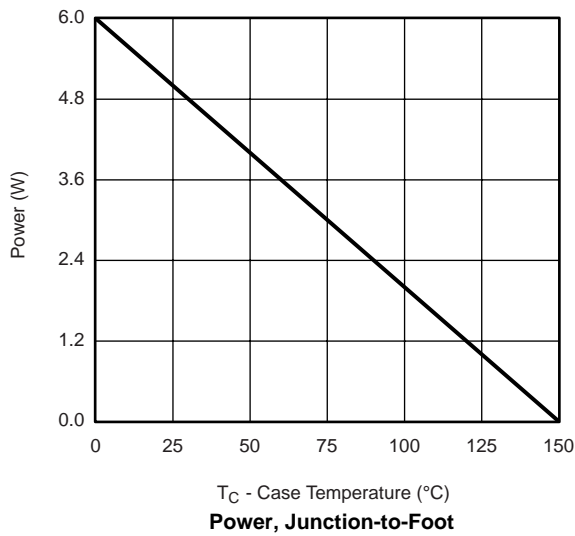
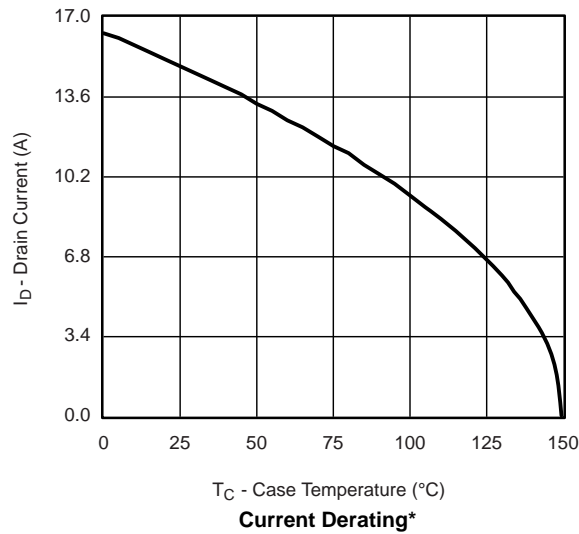

* The power dissipation P_D is based on $T_{J(max)} = 150$ °C, using junction-to-case thermal resistance, and is more useful in settling the upper dissipation limit for cases where additional heatsinking is used. It is used to determine the current rating, when this rating falls below the package limit.

TYPICAL CHARACTERISTICS 25 °C, unless otherwise noted

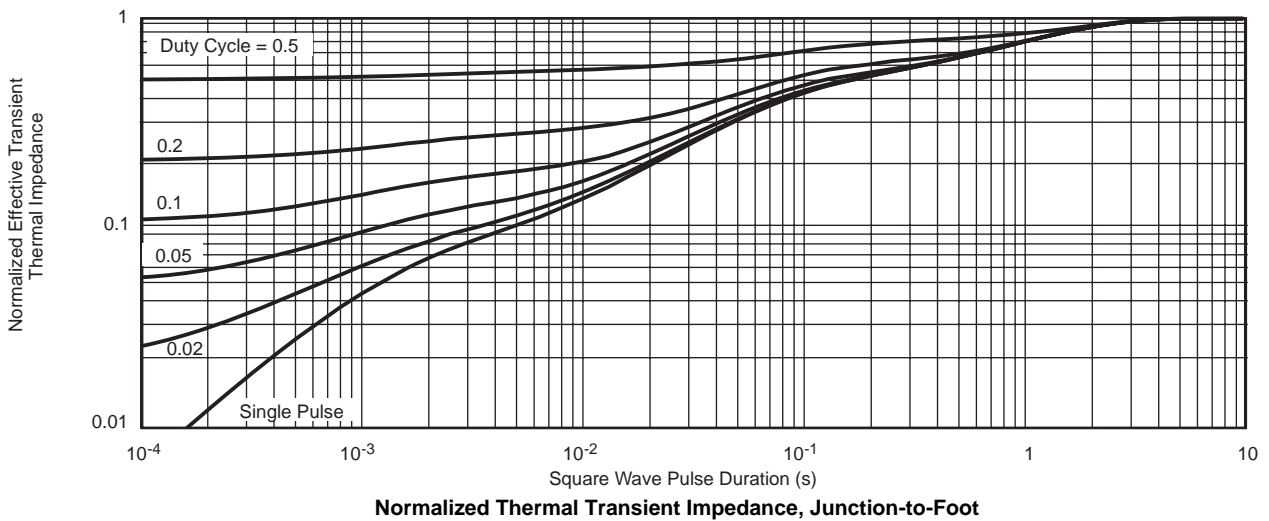
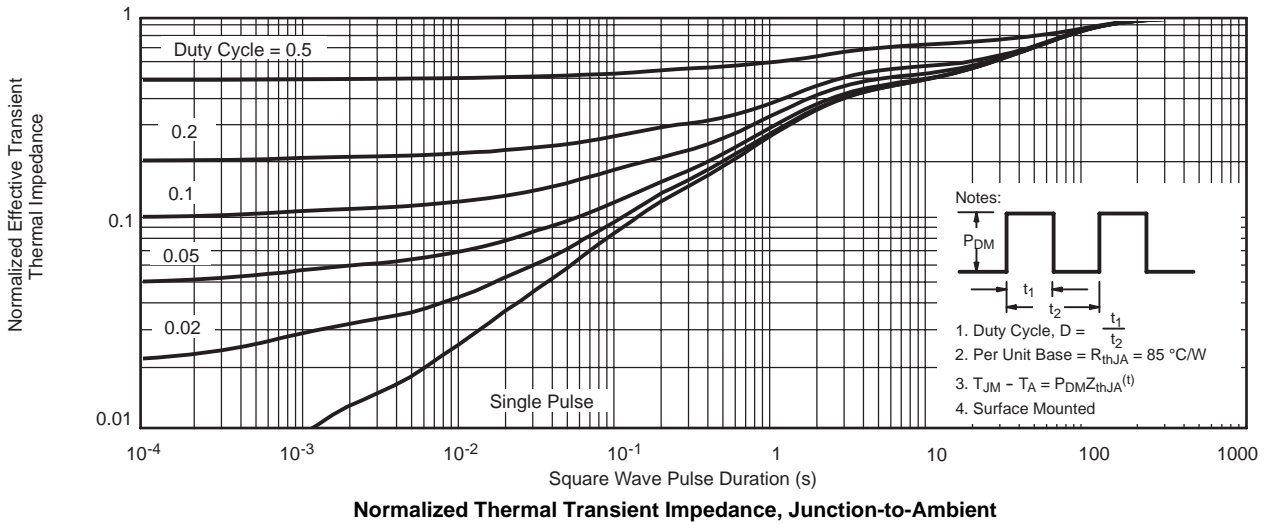

Package Mechanical Data TO-252

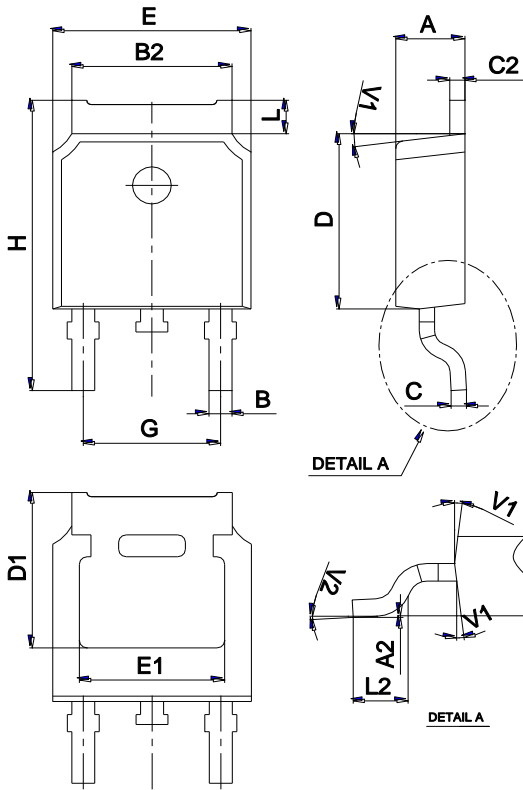

Ref.	Dimensions					
	Millimeters			Inches		
	Min.	Typ.	Max.	Min.	Typ.	Max.
A	2.10		2.50	0.083		0.098
A2	0		0.10	0		0.004
B	0.66		0.86	0.026		0.034
B2	5.18		5.48	0.202		0.216
C	0.40		0.60	0.016		0.024
C2	0.44		0.58	0.017		0.023
D	5.90		6.30	0.232		0.248
D1	5.30REF			0.209REF		
E	6.40		6.80	0.252		0.268
E1	4.63			0.182		
G	4.47		4.67	0.176		0.184
H	9.50		10.70	0.374		0.421
L	1.09		1.21	0.043		0.048
L2	1.35		1.65	0.053		0.065
V1		7°			7°	
V2	0°		6°	0°		6°

Marking

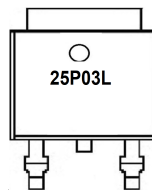

Ordering information

Order code	Package	Baseqty	Deliverymode
NTD25P03LG	TO-252	2500	Tape and reel