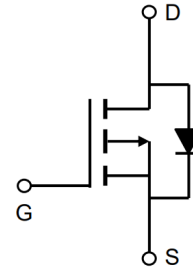


## Description

The IRFR5505TR uses advanced trench technology to provide excellent  $R_{DS(ON)}$ , low gate charge and operation with gate voltages as low as 4.5V. This device is suitable for use as a Battery protection or in other Switching application.



## General Features

$V_{DS} = -60V$   $I_D = -10A$

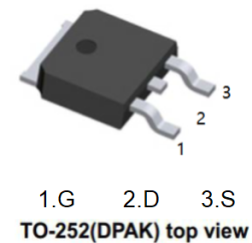
$R_{DS(ON)} < 110\ m\Omega$  @  $V_{GS}=10V$

## Application

Battery protection

Load switch

Uninterruptible power supply



## Absolute Maximum Ratings ( $T_A=25^\circ C$ unless otherwise noted)

Symbol	Parameter	Rating	Units
$V_{DS}$	Drain-Source Voltage	-60	V
$V_{GS}$	Gate-Source Voltage	$\pm 20$	V
$I_D@T_C=25^\circ C$	Continuous Drain Current, $V_{GS}$ @ -10V <sup>1</sup>	-10	A
$I_D@T_C=100^\circ C$	Continuous Drain Current, $V_{GS}$ @ -10V <sup>1</sup>	-8	A
$I_D@T_A=25^\circ C$	Continuous Drain Current, $V_{GS}$ @ -10V <sup>1</sup>	-9	A
$I_D@T_A=70^\circ C$	Continuous Drain Current, $V_{GS}$ @ -10V <sup>1</sup>	-6.5	A
$I_{DM}$	Pulsed Drain Current <sup>2</sup>	-36	A
EAS	Single Pulse Avalanche Energy <sup>3</sup>	25	mJ
$I_{AS}$	Avalanche Current	-26.6	A
$P_D@T_C=25^\circ C$	Total Power Dissipation <sup>4</sup>	3.0	W
$P_D@T_A=25^\circ C$	Total Power Dissipation <sup>4</sup>	2	W
$T_{STG}$	Storage Temperature Range	-55 to 150	$^\circ C$
$T_J$	Operating Junction Temperature Range	-55 to 150	$^\circ C$
$R_{\theta JA}$	Thermal Resistance Junction-Ambient <sup>1</sup>	42	$^\circ C/W$
$R_{\theta JC}$	Thermal Resistance Junction-Case <sup>1</sup>	3.6	$^\circ C/W$

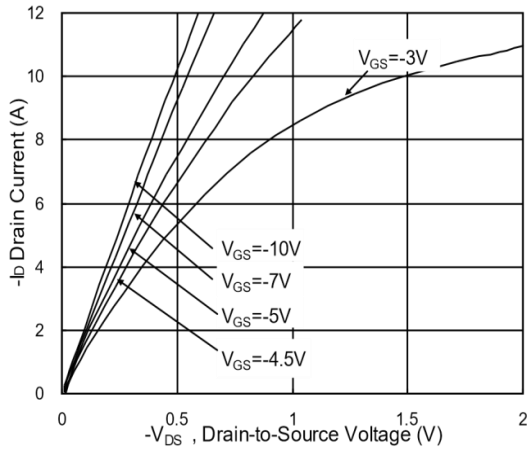
**-60V P-Channel Enhancement Mode MOSFET**
**Electrical Characteristics (T<sub>A</sub>=25°C unless otherwise noted)**

Symbol	Parameter	Conditions	Min.	Typ.	Max.	Unit
BV <sub>DSS</sub>	Drain-Source Breakdown Voltage	V <sub>GS</sub> =0V, I <sub>D</sub> =-250uA	-60			V
ΔBV <sub>DSS</sub> / ΔT <sub>J</sub>	BV <sub>DSS</sub> Temperature Coefficient	Reference to 25°C, I <sub>D</sub> =-1mA		-0.03		V/°C
R <sub>DS(ON)</sub>	Static Drain-Source On-Resistance	V <sub>GS</sub> =-10V, I <sub>D</sub> =-8A		80	110	mΩ
		V <sub>GS</sub> =-4.5V, I <sub>D</sub> =-5A		95	157	
V <sub>GS(th)</sub>	Gate Threshold Voltage	V <sub>GS</sub> =V <sub>DS</sub> , I <sub>D</sub> =-250uA	-1.2	1.5	-2.5	V
ΔV <sub>GS(th)</sub>	V <sub>GS(th)</sub> Temperature Coefficient		4.56			mV/°C
I <sub>DSS</sub>	Drain-Source Leakage Current	V <sub>DS</sub> =-48V, V <sub>GS</sub> =0V, T <sub>J</sub> =25°C			1	uA
		V <sub>DS</sub> =-48V, V <sub>GS</sub> =0V, T <sub>J</sub> =55°C			5	
I <sub>GSS</sub>	Gate-Source Leakage Current	V <sub>GS</sub> =±20V, V <sub>DS</sub> =0V			±100	nA
g <sub>fs</sub>	Forward Transconductance	V <sub>DS</sub> =-5V, I <sub>D</sub> =-12A		15.4		S
R <sub>g</sub>	Gate Resistance	V <sub>DS</sub> =0V, V <sub>GS</sub> =0V, f=1MHz		13.5		Ω
Q <sub>g</sub>	Total Gate Charge (-4.5V)	V <sub>DS</sub> =-48V, V <sub>GS</sub> =-4.5V, I <sub>D</sub> =-10A		9.86		nC
Q <sub>gs</sub>	Gate-Source Charge		3.08			
Q <sub>gd</sub>	Gate-Drain Charge		2.95			
T <sub>d(on)</sub>	Turn-On Delay Time	V <sub>DD</sub> =-15V, V <sub>GS</sub> =-10V, R <sub>G</sub> =3.3Ω, I <sub>D</sub> =-1A		28.8		ns
T <sub>r</sub>	Rise Time		19.8			
T <sub>d(off)</sub>	Turn-Off Delay Time		60.8			
T <sub>f</sub>	Fall Time		7.2			
C <sub>iss</sub>	Input Capacitance	V <sub>DS</sub> =-15V, V <sub>GS</sub> =0V, f=1MHz		800		pF
C <sub>oss</sub>	Output Capacitance		97.3			
C <sub>rss</sub>	Reverse Transfer Capacitance		70			
I <sub>S</sub>	Continuous Source Current <sup>1,5</sup>	V <sub>G</sub> =V <sub>D</sub> =0V, Force Current			-18	A
I <sub>SM</sub>	Pulsed Source Current <sup>2,5</sup>				-36	A
V <sub>SD</sub>	Diode Forward Voltage <sup>2</sup>	V <sub>GS</sub> =0V, I <sub>S</sub> =-1A, T <sub>J</sub> =25°C			-1.2	V

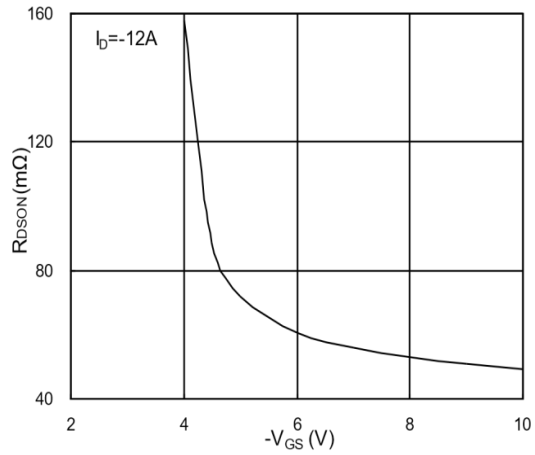
Note :

- 1.The data tested by surface mounted on a 1 inch<sup>2</sup> FR-4 board with 20Z copper.
- 2.The data tested by pulsed, pulse width ≤ 300us, duty cycle ≤ 2%
- 3.The EAS data shows Max. rating. The test condition is V<sub>DD</sub>=-25V, V<sub>GS</sub>=-10V, L=0.1mH, I<sub>AS</sub>=-26.6A
- 4.The power dissipation is limited by 150°C junction temperature
- 5.The data is theoretically the same as I<sub>D</sub> and I<sub>DM</sub>, in real applications, should be limited by total power dissipation.

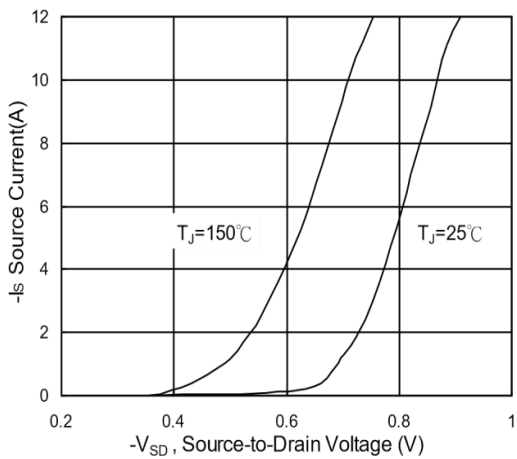
**Typical Characteristics**



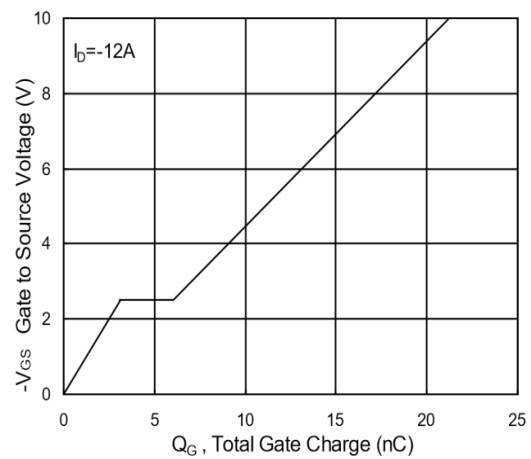
**Fig.1 Typical Output Characteristics**



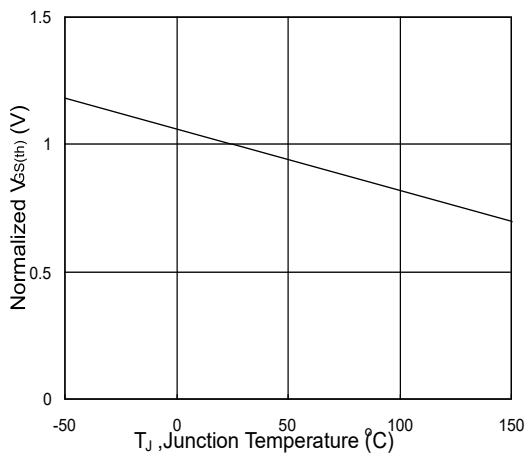
**Fig.2 On-Resistance v.s Gate-Source**



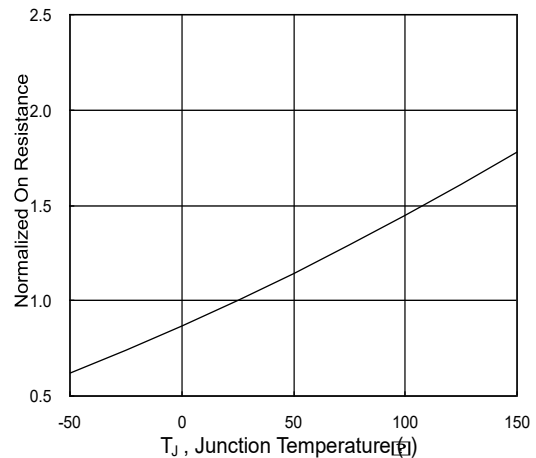
**Fig.3 Forward Characteristics of Reverse**



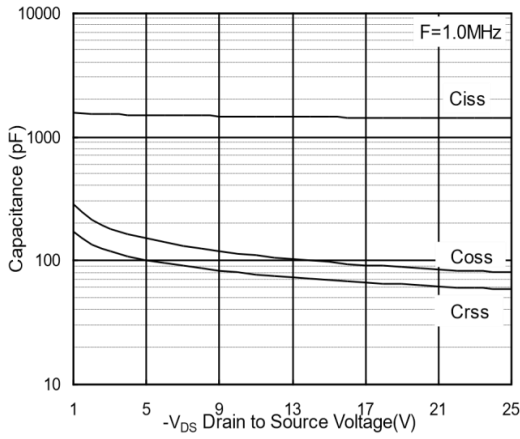
**Fig.4 Gate-Charge Characteristics**



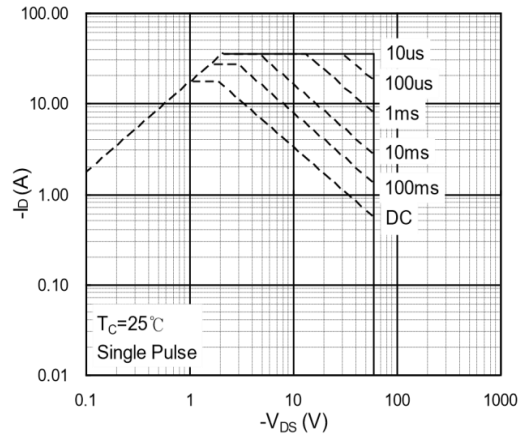
**Fig.5 Normalized  $V_{GS(th)}$  v.s  $T_j$**



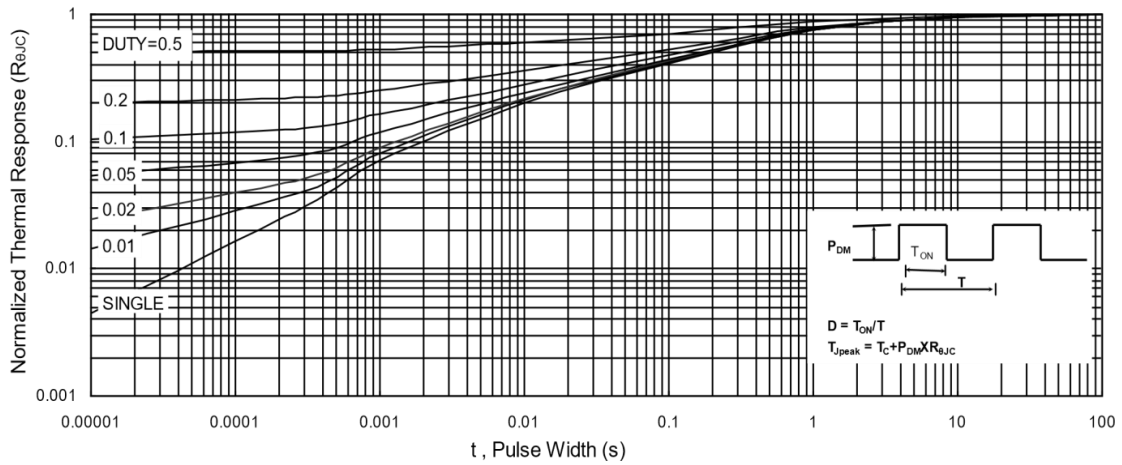
**Fig.6 Normalized  $R_{DS(on)}$  v.s  $T_j$**



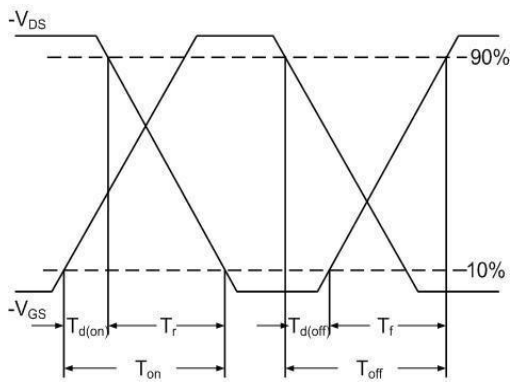
**Fig.7 Capacitance**



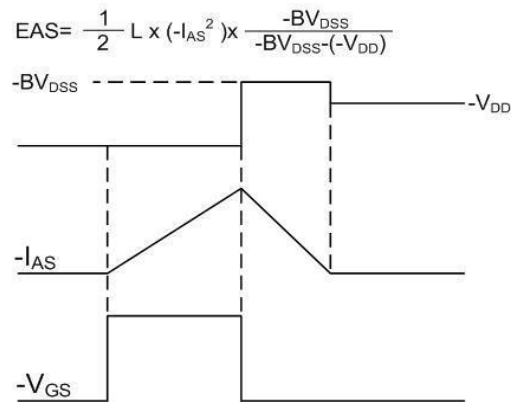
**Fig.8 Safe Operating Area**



**Fig.9 Normalized Maximum Transient Thermal Impedance**

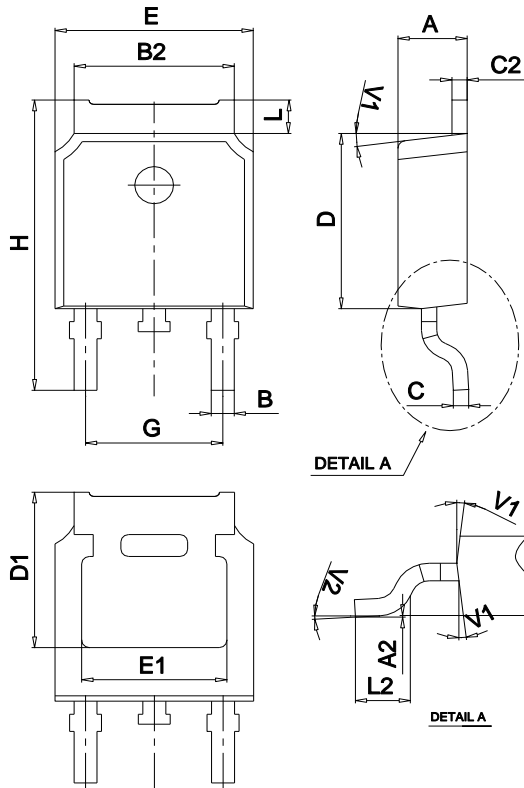


**Fig.10 Switching Time Waveform**



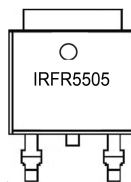
**Fig.11 Unclamped Inductive Waveform**

**Package Mechanical Data TO-252**



Ref.	Dimensions					
	Millimeters			Inches		
	Min.	Typ.	Max.	Min.	Typ.	Max.
A	2.10		2.50	0.083		0.098
A2	0		0.10	0		0.004
B	0.66		0.86	0.026		0.034
B2	5.18		5.48	0.202		0.216
C	0.40		0.60	0.016		0.024
C2	0.44		0.58	0.017		0.023
D	5.90		6.30	0.232		0.248
D1	5.30REF			0.209REF		
E	6.40		6.80	0.252		0.268
E1	4.63			0.182		
G	4.47		4.67	0.176		0.184
H	9.50		10.70	0.374		0.421
L	1.09		1.21	0.043		0.048
L2	1.35		1.65	0.053		0.065
V1		7°			7°	
V2		0°	6°	0°		6°

**Marking**



**Ordering information**

Order code	Package	Baseqty	Deliverymode
IRFR5505TR	TO-252	2500	Tape and reel