

PRODUCT SUMMARY

- V_{DS} (V) = -60V
- $R_{DS(ON)} < 15m\Omega$ ($V_{GS} = -10V$)
- $R_{DS(ON)} < 20m\Omega$ ($V_{GS} = -4.5V$)

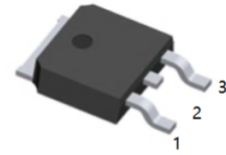

1.G 2.D 3.S
TO-252(DPAK) top view

APPLICATIONS

- Load Switch

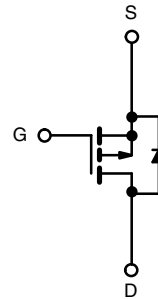

ABSOLUTE MAXIMUM RATINGS($T_A = 25\text{ }^\circ\text{C}$, unless otherwise noted)

Parameter	Symbol	Limit	Unit	
Drain-Source Voltage	V_{DS}	- 60	V	
Gate-Source Voltage	V_{GS}	± 20		
Continuous Drain Current ($T_J = 175\text{ }^\circ\text{C}$)	I_D	$T_C = 25\text{ }^\circ\text{C}$	- 50 ^d	A
		$T_C = 125\text{ }^\circ\text{C}$	- 27.5	
Pulsed Drain Current	I_{DM}	- 80		
Avalanche Current	I_{AS}	- 50		
Single Pulse Avalanche Energy ^a	E_{AS}	125	mJ	
Power Dissipation	P_D	$T_C = 25\text{ }^\circ\text{C}$	113 ^c	W
		$T_A = 25\text{ }^\circ\text{C}$	2.5 ^{b, c}	
Operating Junction and Storage Temperature Range	T_J, T_{stg}	- 55 to 150	$^\circ\text{C}$	

THERMAL RESISTANCE RATINGS

Parameter	Symbol	Typical	Maximum	Unit	
Junction-to-Ambient ^b	R_{thJA}	$t \leq 10\text{ s}$	15	18	$^\circ\text{C/W}$
		Steady State	40	50	
Junction-to-Case	R_{thJC}	0.82	1.1		

Notes:

- a. Duty cycle $\leq 1\%$.
- b. When mounted on 1" square PCB (FR-4 material).
- c. See SOA curve for voltage derating.
- d. Package limited.

SPECIFICATIONS ($T_J = 25\text{ °C}$, unless otherwise noted)

Parameter	Symbol	Test Conditions	Min.	Typ.	Max.	Unit
Static						
Drain-Source Breakdown Voltage	V_{DS}	$V_{GS} = 0\text{ V}, I_D = -250\text{ }\mu\text{A}$	-60			V
Gate Threshold Voltage	$V_{GS(th)}$	$V_{DS} = V_{GS}, I_D = -250\text{ }\mu\text{A}$	-1.1	-1.8	-2.5	
Gate-Body Leakage	I_{GSS}	$V_{DS} = 0\text{ V}, V_{GS} = \pm 20\text{ V}$			± 100	nA
Zero Gate Voltage Drain Current	I_{DSS}	$V_{DS} = -60\text{ V}, V_{GS} = 0\text{ V}$			-1	μA
		$V_{DS} = -60\text{ V}, V_{GS} = 0\text{ V}, T_J = 125\text{ °C}$			-50	
		$V_{DS} = -60\text{ V}, V_{GS} = 0\text{ V}, T_J = 150\text{ °C}$			-100	
On-State Drain Current ^a	$I_{D(on)}$	$V_{DS} = -5\text{ V}, V_{GS} = -10\text{ V}$	-50			A
Drain-Source On-State Resistance ^a	$R_{DS(on)}$	$V_{GS} = -10\text{ V}, I_D = -17\text{ A}$		12	15	m Ω
		$V_{GS} = -10\text{ V}, I_D = -50\text{ A}, T_J = 125\text{ °C}$			25	
		$V_{GS} = -10\text{ V}, I_D = -50\text{ A}, T_J = 150\text{ °C}$			28	
		$V_{GS} = -4.5\text{ V}, I_D = -14\text{ A}$			20	
Forward Transconductance ^a	g_{fs}	$V_{DS} = -15\text{ V}, I_D = -17\text{ A}$		61		S
Dynamic^b						
Input Capacitance	C_{iss}	$V_{GS} = 0\text{ V}, V_{DS} = -25\text{ V}, f = 1\text{ MHz}$		4950		pF
Output Capacitance	C_{oss}			480		
Reverse Transfer Capacitance	C_{rss}			405		
Total Gate Charge ^c	Q_g	$V_{DS} = -30\text{ V}, V_{GS} = -10\text{ V}, I_D = -50\text{ A}$		110	165	nC
Gate-Source Charge ^c	Q_{gs}			19		
Gate-Drain Charge ^c	Q_{gd}			28		
Turn-On Delay Time ^c	$t_{d(on)}$	$V_{DD} = -30\text{ V}, R_L = 0.6\text{ }\Omega$ $I_D \cong -50\text{ A}, V_{GEN} = -10\text{ V}, R_G = 6\text{ }\Omega$		15	23	ns
Rise Time ^c	t_r			70	105	
Turn-Off Delay Time ^c	$t_{d(off)}$			175	260	
Fall Time ^c	t_f			175	260	
Source-Drain Diode Ratings and Characteristics $T_C = 25\text{ °C}$^b						
Continuous Current	I_S				-50	A
Pulsed Current	I_{SM}				-80	
Forward Voltage ^a	V_{SD}	$I_F = -50\text{ A}, V_{GS} = 0\text{ V}$		-1	-1.6	V
Reverse Recovery Time	t_{rr}	$I_F = -50\text{ A}, dI/dt = 100\text{ A}/\mu\text{s}$		45	70	ns

Notes:

- a. Pulse test; pulse width $\leq 300\text{ }\mu\text{s}$, duty cycle $\leq 2\%$.
- b. Guaranteed by design, not subject to production testing.
- c. Independent of operating temperature.

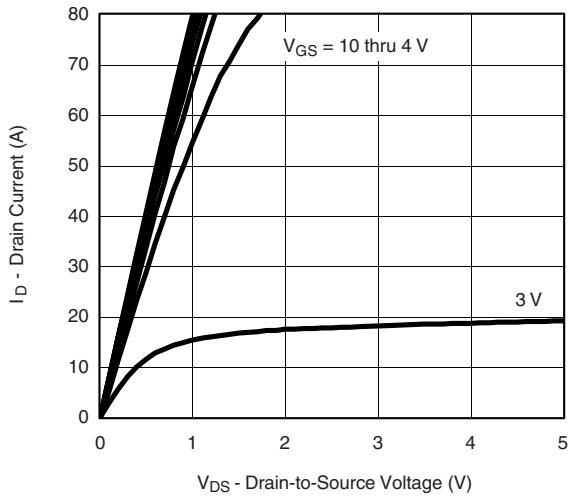

Output Characteristics

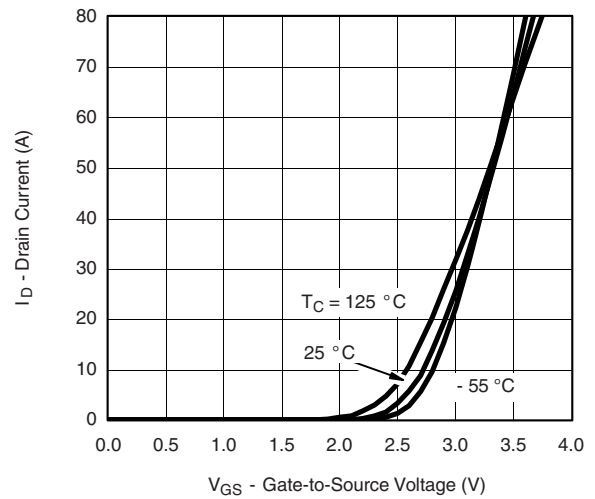

Transfer Characteristics

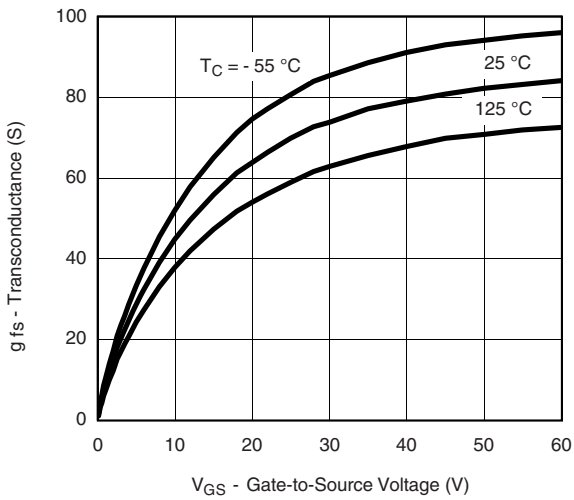

Transconductance

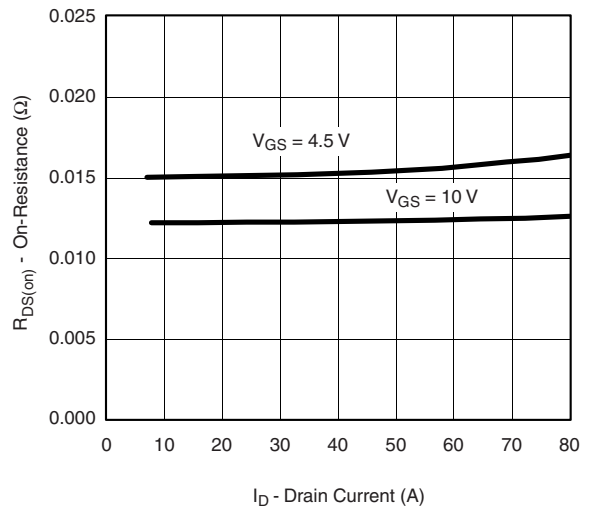

On-Resistance vs. Drain Current

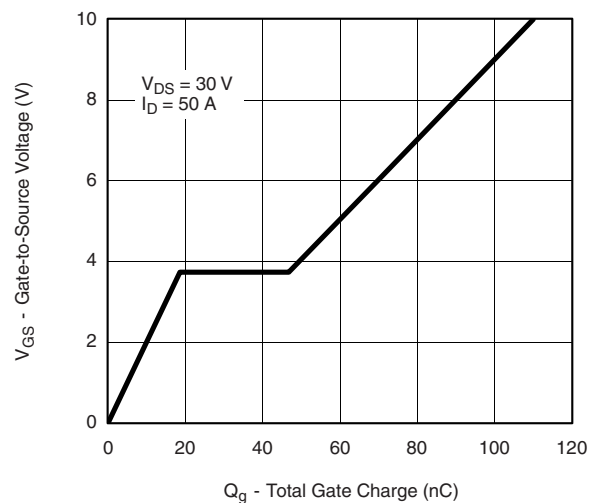
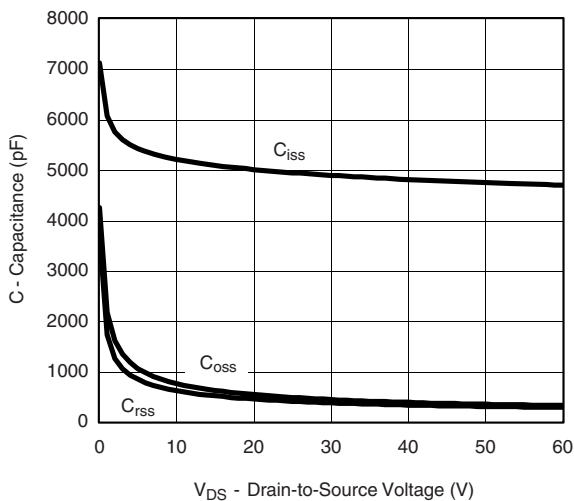

TYPICAL CHARACTERISTICS

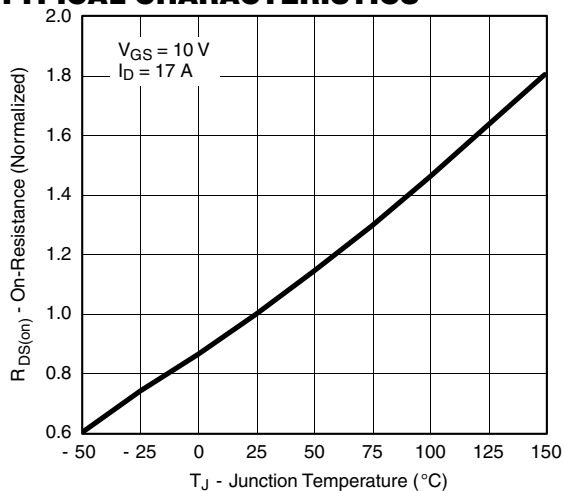

On-Resistance vs. Junction Temperature

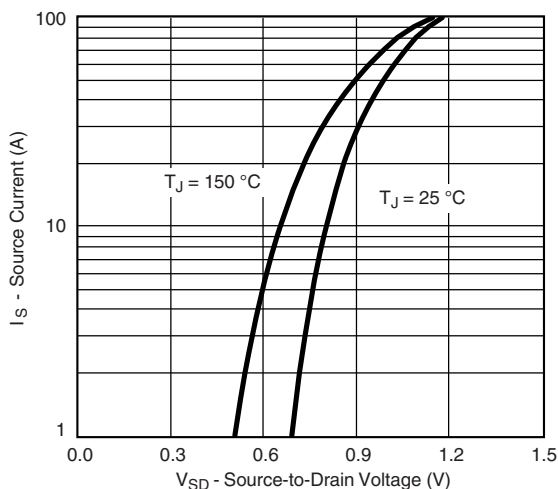

Source-Drain Diode Forward Voltage

THERMAL RATINGS (25 °C, unless otherwise noted)

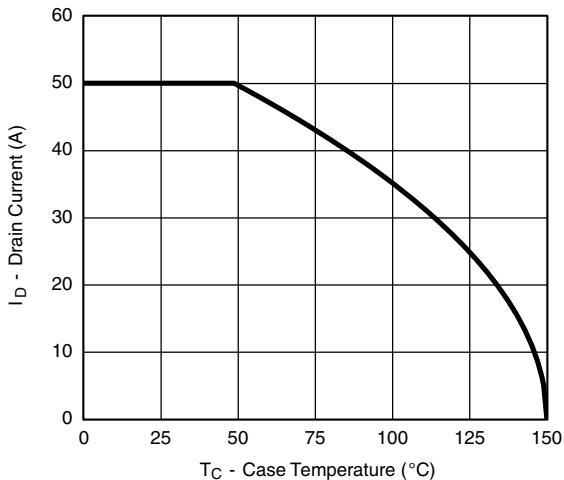

Drain Current vs. Case Temperature

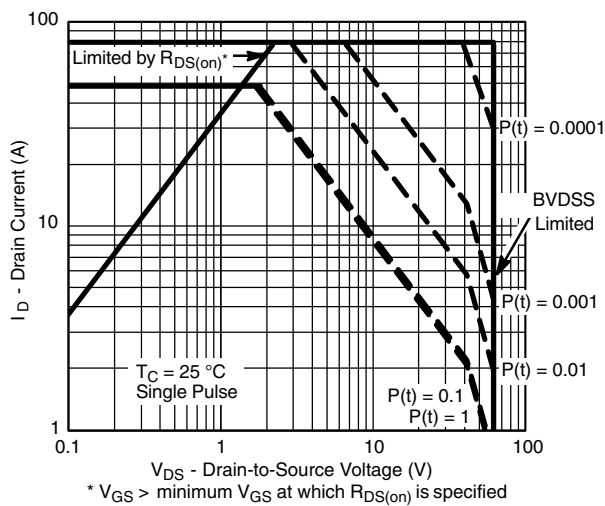

Safe Operating Area

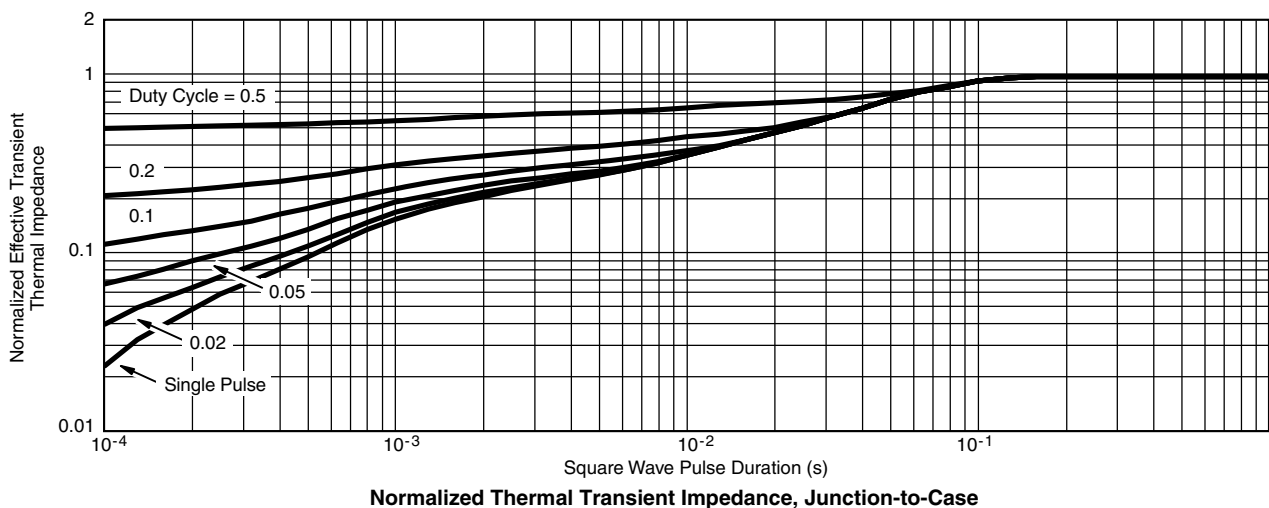

Normalized Thermal Transient Impedance, Junction-to-Case

Package Mechanical Data TO-252

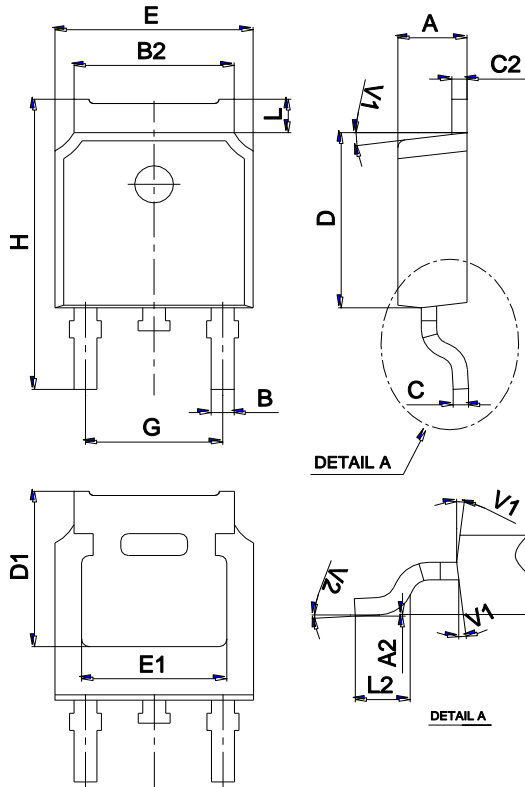

Ref.	Dimensions					
	Millimeters			Inches		
	Min.	Typ.	Max.	Min.	Typ.	Max.
A	2.10		2.50	0.083		0.098
A2	0		0.10	0		0.004
B	0.66		0.86	0.026		0.034
B2	5.18		5.48	0.202		0.216
C	0.40		0.60	0.016		0.024
C2	0.44		0.58	0.017		0.023
D	5.90		6.30	0.232		0.248
D1	5.30REF			0.209REF		
E	6.40		6.80	0.252		0.268
E1	4.63			0.182		
G	4.47		4.67	0.176		0.184
H	9.50		10.70	0.374		0.421
L	1.09		1.21	0.043		0.048
L2	1.35		1.65	0.053		0.065
V1		7°			7°	
V2	0°		6°	0°		6°

Marking

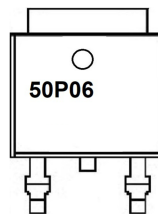

Ordering information

Order code	Package	Baseqty	Deliverymode
SUD50P06-15	TO-252	2500	Tape and reel