

Features

- V_{DS} (V) = -60V
- $R_{DS(ON)} < 27m\Omega$ ($V_{GS} = -10V$)
- $R_{DS(ON)} < 35m\Omega$ ($V_{GS} = -4.5V$)
- Very low on-resistance
- Very low gate charge
- High avalanche ruggedness
- Low gate drive power loss

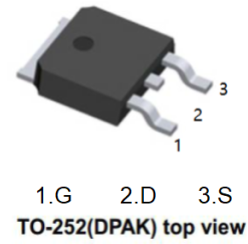

Applications

- Switching applications

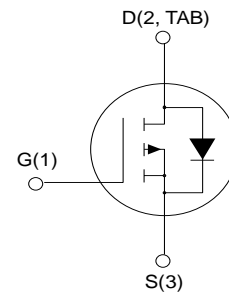

Electrical ratings

Table 2: Absolute maximum ratings

Symbol	Parameter	Value	Unit
V_{DS}	Drain-source voltage	60	V
V_{GS}	Gate-source voltage	± 20	V
I_D	Drain current (continuous) at $T_C = 25\text{ }^\circ\text{C}$	35	A
I_D	Drain current (continuous) at $T_C = 100\text{ }^\circ\text{C}$	25	A
$I_{DM}^{(1)}$	Drain current (pulsed)	140	A
P_{TOT}	Total dissipation at $T_C = 25\text{ }^\circ\text{C}$	70	W
T_{stg}	Storage temperature range	-55 to 175	$^\circ\text{C}$
T_j	Operating junction temperature range		

Notes:

⁽¹⁾Pulse width limited by safe operating area.

Table 3: Thermal data

Symbol	Parameter	Value	Unit
$R_{thj-case}$	Thermal resistance junction-case max	2.14	$^\circ\text{C/W}$

Electrical characteristics

 (T_C = 25 °C unless otherwise specified)

Table 4: Static

Symbol	Parameter	Test conditions	Min.	Typ.	Max.	Unit
V _{(BR)DSS}	Drain-source breakdown voltage	V _{GS} = 0 V, I _D = 250 μA	60			V
I _{DSS}	Zero gate voltage Drain current	V _{GS} = 0 V, V _{DS} = 60 V			1	μA
		V _{GS} = 0 V, V _{DS} = 60 V, T _C = 125 °C ⁽¹⁾			10	μA
I _{GSS}	Gate-body leakage current	V _{DS} = 0 V, V _{GS} = ± 20 V			±100	nA
V _{GS(th)}	Gate threshold voltage	V _{DS} = V _{GS} , I _D = 250 μA	-1.1	-1.8	-2.5	V
R _{DS(on)}	Static drain-source on-resistance	V _{GS} = 10 V, I _D = 17.5 A		25	27	mΩ
		V _{GS} = 4.5 V, I _D = 17.5 A		30	35	

Notes:
⁽¹⁾Defined by design, not subject to production test.

Table 5: Dynamic

Symbol	Parameter	Test conditions	Min.	Typ.	Max.	Unit
C _{iss}	Input capacitance	V _{DS} = 25 V, f = 1 MHz, V _{GS} = 0 V		3780		pF
C _{oss}	Output capacitance			262		pF
C _{riss}	Reverse transfer capacitance			170		pF
Q _g	Total gate charge	V _{DD} = 30 V, I _D = 35 A, V _{GS} = 0 to 4.5 V (see Figure 14: "Gate charge test circuit")		30		nC
Q _{gs}	Gate-source charge			10.8		nC
Q _{gd}	Gate-drain charge			10.5		nC
R _G	Gate input resistance	I _D = 0 A, gate DC bias = 0 V, f = 1 MHz, magnitude of alternative signal = 20 mV		1.7		Ω

Table 6: Switching times

Symbol	Parameter	Test conditions	Min.	Typ.	Max.	Unit
t _{d(on)}	Turn-on delay time	V _{DD} = 30 V, I _D = 17.5 A, R _G = 4.7 Ω, V _{GS} = 10 V (see Figure 13: "Switching times test circuit for resistive load")		51.4		ns
t _r	Rise time			39		ns
t _{d(off)}	Turn-off-delay time			171		ns
t _f	Fall time			21		ns

Table 7: Source drain diode

Symbol	Parameter	Test conditions	Min.	Typ.	Max.	Unit
V _{SD} ⁽¹⁾	Forward on voltage	V _{GS} = 0 V, I _{SD} = 35 A			1.5	V
t _{rr}	Reverse recovery time	I _{SD} = 35 A, di/dt = 100 A/μs, V _{DD} = 48 V, (see Figure 15: "Test circuit for inductive load switching and diode recovery times")		34		ns
Q _{rr}	Reverse recovery charge			48		nC
I _{RRM}	Reverse recovery current			2.8		A

Notes:
⁽¹⁾Pulse test: pulse duration = 300 μs, duty cycle 1.5%

Electrical characteristics (curves)

Figure 2: Safe operating area

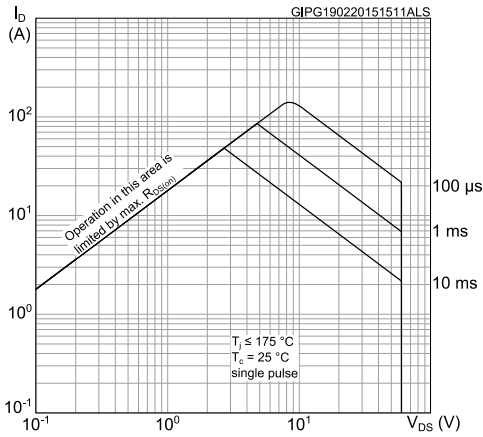

Figure 3: Thermal impedance

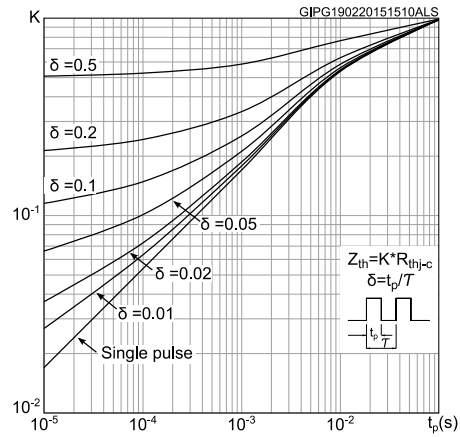

Figure 4: Output characteristics

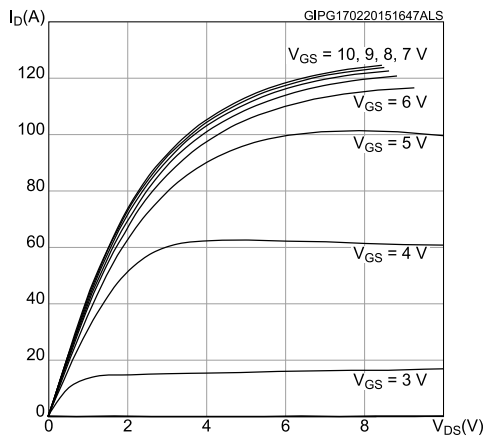

Figure 5: Transfer characteristics

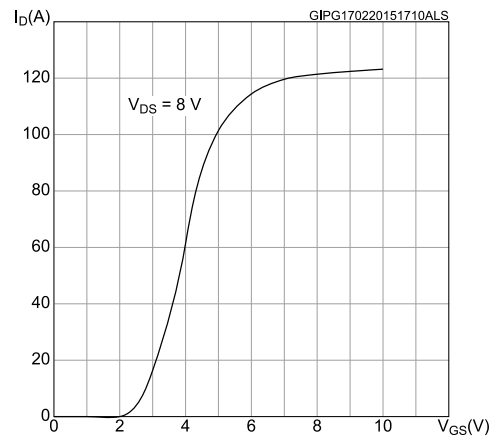

Figure 6: Normalized gate threshold voltage vs temperature

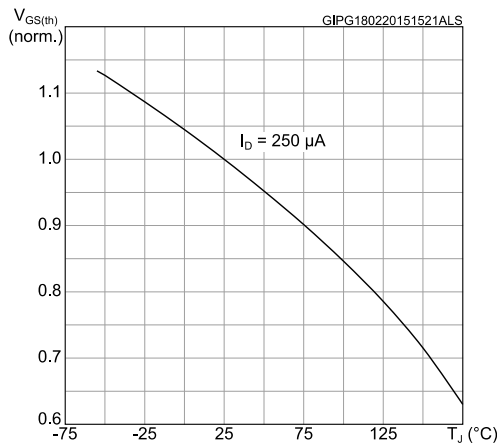

Figure 7: Normalized V(BR)DSS vs temperature

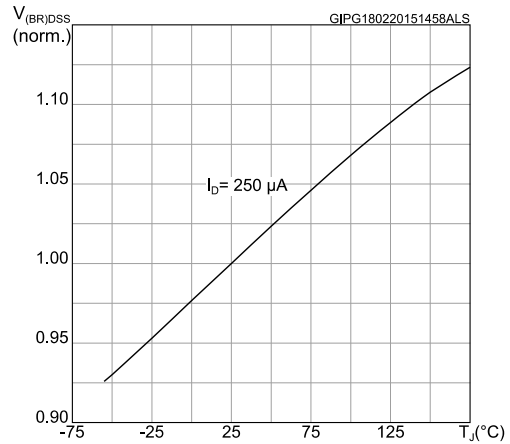

Figure 8: Static drain-source on-resistance

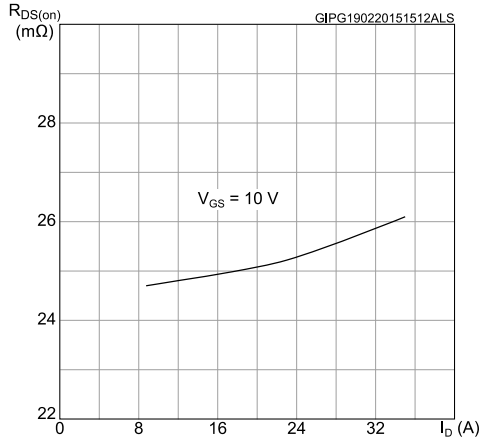

Figure 9: Normalized on-resistance vs. temperature

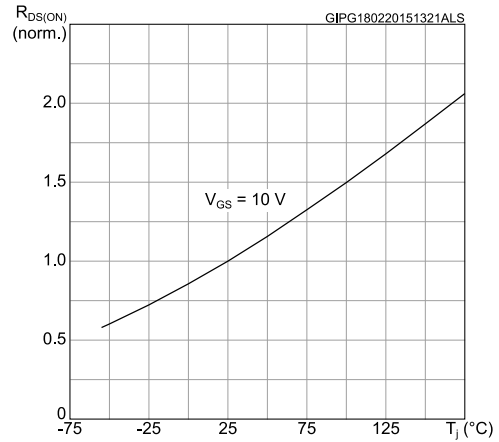

Figure 10: Gate charge vs gate-source voltage

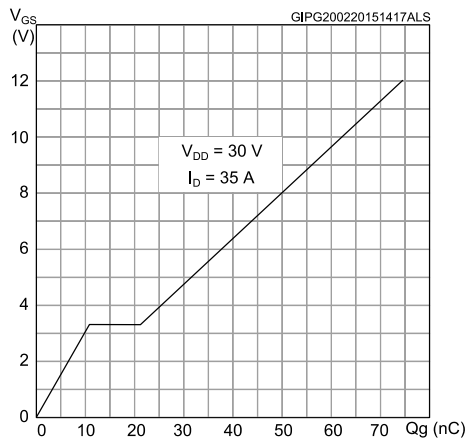

Figure 11: Capacitance variations voltage

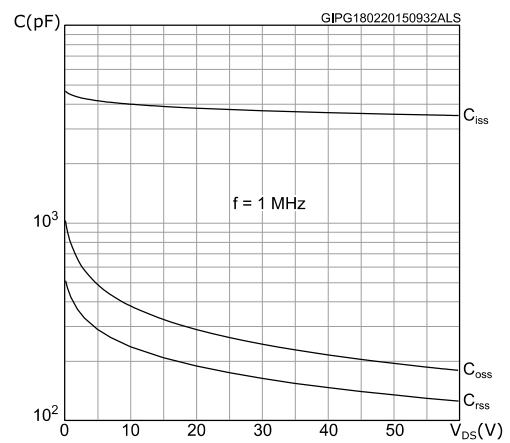
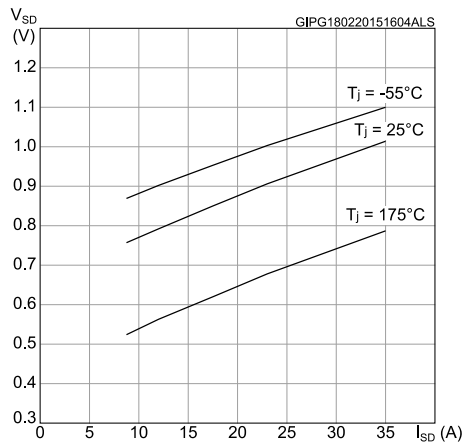
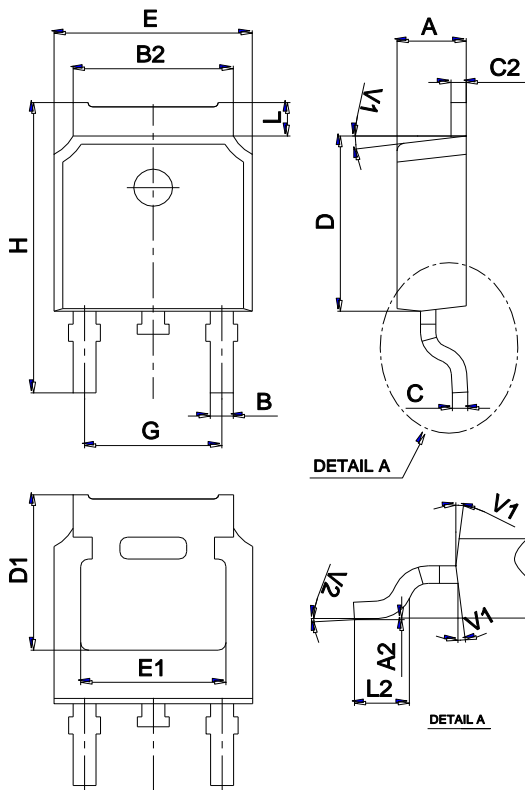

Figure 12: Source-drain diode forward characteristics



Package Mechanical Data TO-252



Ref.	Dimensions					
	Millimeters			Inches		
	Min.	Typ.	Max.	Min.	Typ.	Max.
A	2.10		2.50	0.083		0.098
A2	0		0.10	0		0.004
B	0.66		0.86	0.026		0.034
B2	5.18		5.48	0.202		0.216
C	0.40		0.60	0.016		0.024
C2	0.44		0.58	0.017		0.023
D	5.90		6.30	0.232		0.248
D1	5.30REF			0.209REF		
E	6.40		6.80	0.252		0.268
E1	4.63			0.182		
G	4.47		4.67	0.176		0.184
H	9.50		10.70	0.374		0.421
L	1.09		1.21	0.043		0.048
L2	1.35		1.65	0.053		0.065
V1		7°			7°	
V2	0°		6°	0°		6°

Marking

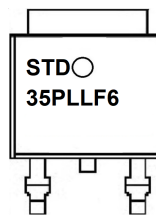

Ordering information

Order code	Package	Baseqty	Deliverymode
STD35P6LLF6	TO-252	2500	Tape and reel