

**SOT-23-3L Plastic-Encapsulate MOSFETS**

■ **Features**

- $V_{DS} (V) = 40V$
- $I_D = 5.6 A (V_{GS} = 10V)$
- $R_{DS(ON)} < 42m\Omega (V_{GS} = 10V)$
- $R_{DS(ON)} < 51m\Omega (V_{GS} = 4.5V)$
- Pb-Free Package May be Available. The G-Suffix Denotes a Pb-Free Lead Finish

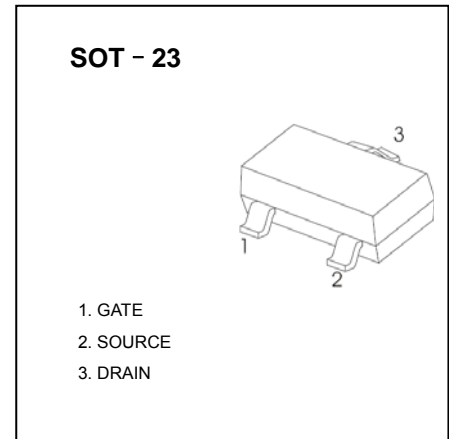

**Equivalent Circuit**

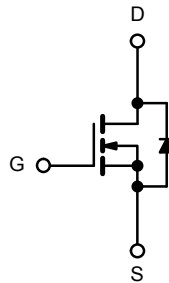

■ **Absolute Maximum Ratings  $T_a = 25^\circ C$**

Parameter		Symbol	Rating	Unit
Drain-Source Voltage		$V_{DS}$	40	V
Gate-Source Voltage		$V_{GS}$	$\pm 20$	
Continuous Drain Current	$T_c=25^\circ C$	$I_D$	5.6	A
	$T_c=70^\circ C$		4.5	
	$T_a=25^\circ C$		4.3	
	$T_a=70^\circ C$		3.5	
Pulsed Drain Current		$I_{DM}$	20	
Power Dissipation	$T_c=25^\circ C$	$P_D$	2.1	W
	$T_c=70^\circ C$		1.3	
	$T_a=25^\circ C$		1.25	
	$T_a=70^\circ C$		0.8	
Thermal Resistance.Junction- to-Ambient		$R_{thJA}$	100	$^\circ C/W$
Thermal Resistance.Junction- to-Foot		$R_{thJF}$	60	
Junction Temperature		$T_J$	150	$^\circ C$
Storage Temperature Range		$T_{stg}$	-55 to 150	

**SOT-23-3L Plastic-Encapsulate MOSFETS**

■ Electrical Characteristics Ta = 25°C

Parameter	Symbol	Test Conditions	Min	Typ	Max	Unit
Drain-Source Breakdown Voltage	V <sub>DSS</sub>	I <sub>D</sub> =250 μ A, V <sub>GS</sub> =0V	40			V
Zero Gate Voltage Drain Current	I <sub>DSS</sub>	V <sub>DS</sub> =40V, V <sub>GS</sub> =0V			1	μA
		V <sub>DS</sub> =40V, V <sub>GS</sub> =0V, T <sub>J</sub> =70°C			10	
Gate-Body Leakage Current	I <sub>GSS</sub>	V <sub>DS</sub> =0V, V <sub>GS</sub> =±20V			±100	nA
Gate Threshold Voltage	V <sub>GS(th)</sub>	V <sub>DS</sub> =V <sub>GS</sub> , I <sub>D</sub> =250μA	1.2		2.5	V
Static Drain-Source On-Resistance	R <sub>DS(on)</sub>	V <sub>GS</sub> =10V, I <sub>D</sub> =4.3A			42	mΩ
		V <sub>GS</sub> =4.5V, I <sub>D</sub> =3.9A			51	
On State Drain Current	I <sub>D(ON)</sub>	V <sub>DS</sub> ≥5V, V <sub>GS</sub> =10V	20			A
Forward Transconductance	g <sub>FS</sub>	V <sub>DS</sub> =20V, I <sub>D</sub> =4.3A		17		S
Input Capacitance	C <sub>iss</sub>	V <sub>GS</sub> =0V, V <sub>DS</sub> =20V, f=1MHz		340		pF
Output Capacitance	C <sub>oss</sub>			60		
Reverse Transfer Capacitance	C <sub>rss</sub>			30		
Gate Resistance	R <sub>g</sub>	V <sub>GS</sub> =0V, V <sub>DS</sub> =0V, f=1MHz	0.6		6.6	Ω
Total Gate Charge	Q <sub>g</sub>	V <sub>GS</sub> =20V, V <sub>DS</sub> =10V, I <sub>D</sub> =4.3A		5.8	9	nC
				2.9	6	
Gate Source Charge	Q <sub>gs</sub>	V <sub>GS</sub> =20V, V <sub>DS</sub> =4.5V, I <sub>D</sub> =4.3A		1.1		
Gate Drain Charge	Q <sub>gd</sub>			0.9		
Turn-On DelayTime	t <sub>d(on)</sub>	V <sub>DD</sub> = 20V, R <sub>L</sub> = 5.7Ω I <sub>D</sub> =3.5A, V <sub>GEN</sub> = 4.5V, R <sub>G</sub> = 1Ω		12	20	ns
Turn-On Rise Time	t <sub>r</sub>			50	75	
Turn-Off DelayTime	t <sub>d(off)</sub>			10	20	
Turn-Off Fall Time	t <sub>f</sub>			8	16	
Turn-On DelayTime	t <sub>d(on)</sub>	V <sub>DD</sub> = 20V, R <sub>L</sub> = 5.7Ω I <sub>D</sub> =3.5A, V <sub>GEN</sub> = 10V, R <sub>G</sub> = 1Ω		7	14	ns
Turn-On Rise Time	t <sub>r</sub>			20	30	
Turn-Off DelayTime	t <sub>d(off)</sub>			14	21	
Turn-Off Fall Time	t <sub>f</sub>			8	16	
Body Diode Reverse Recovery Time	t <sub>rr</sub>	I <sub>F</sub> =3.5A, dI/dt=100A/μs, T <sub>J</sub> =25°C		15	23	nC
Body Diode Reverse Recovery Charge	Q <sub>rr</sub>			7	14	
Reverse Recovery Fall Time	t <sub>a</sub>			11		ns
Reverse Recovery Rise Time	t <sub>b</sub>			4		
Maximum Body-Diode Continuous Current	I <sub>S</sub>	T <sub>C</sub> =25°C			1.75	A
Pulse Diode Forward Current	I <sub>SM</sub>				20	
Diode Forward Voltage	V <sub>SD</sub>	I <sub>S</sub> =3.5A, V <sub>GS</sub> =0V			1.2	V

**SOT-23-3L Plastic-Encapsulate MOSFETS**

■ Typical Characteristics

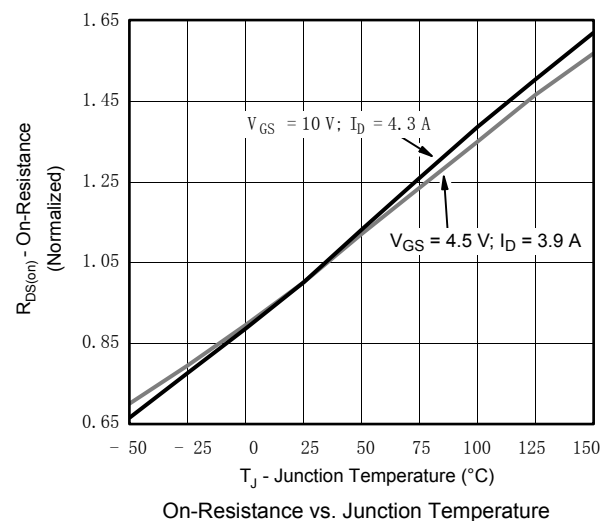
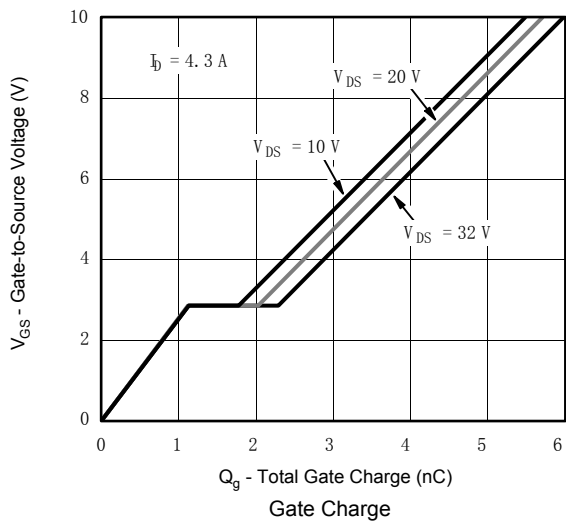
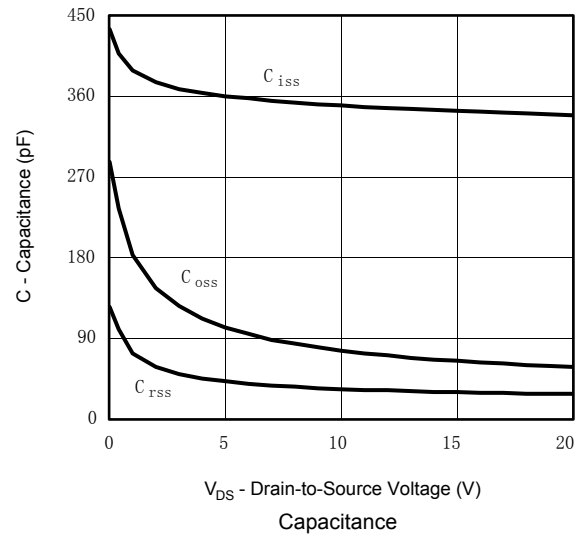
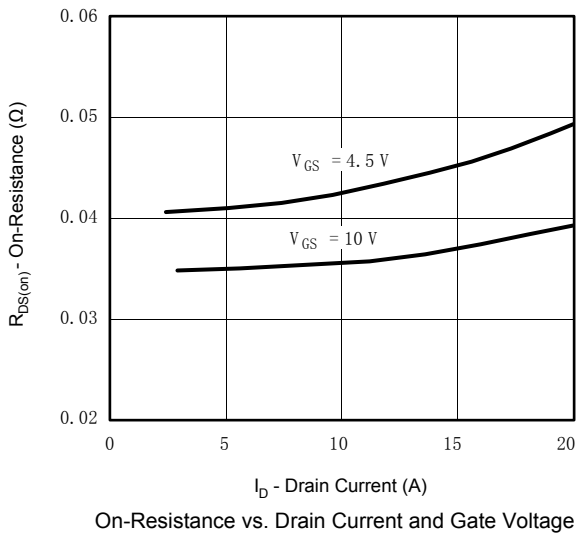
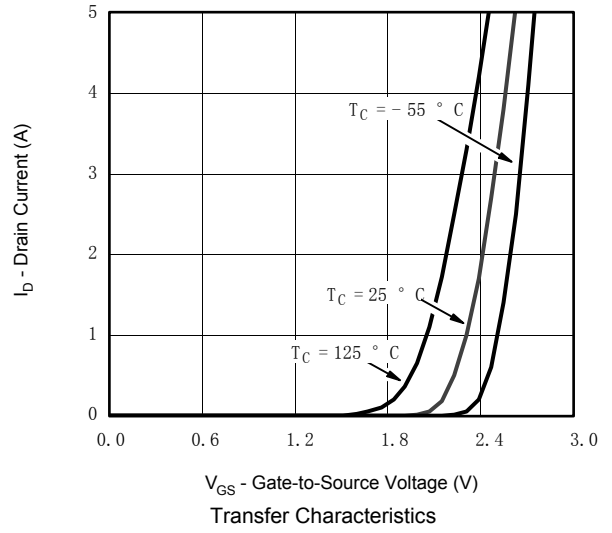
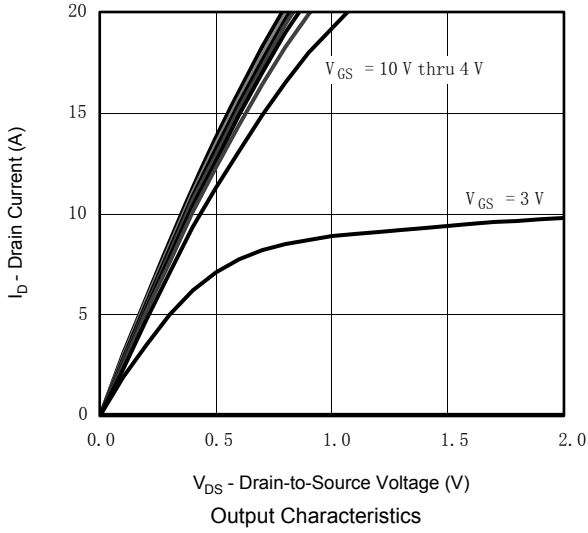

**SOT-23-3L Plastic-Encapsulate MOSFETS**

■ Typical Characteristics

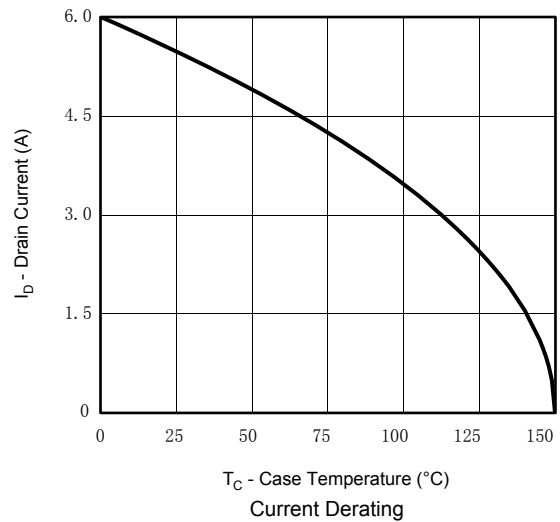
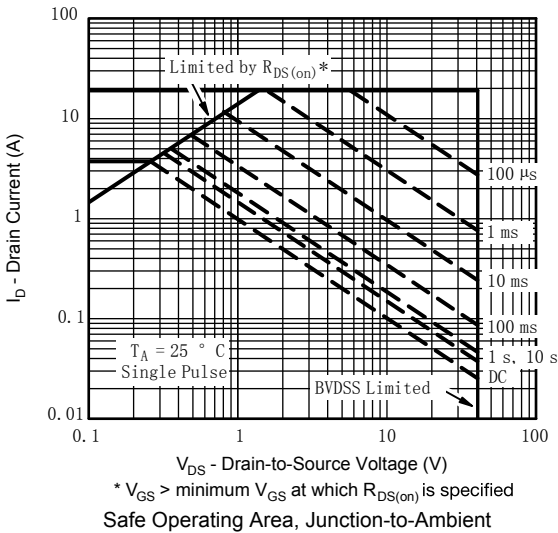
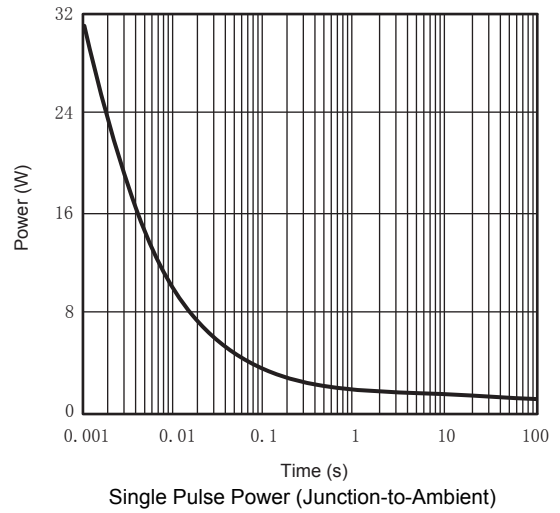
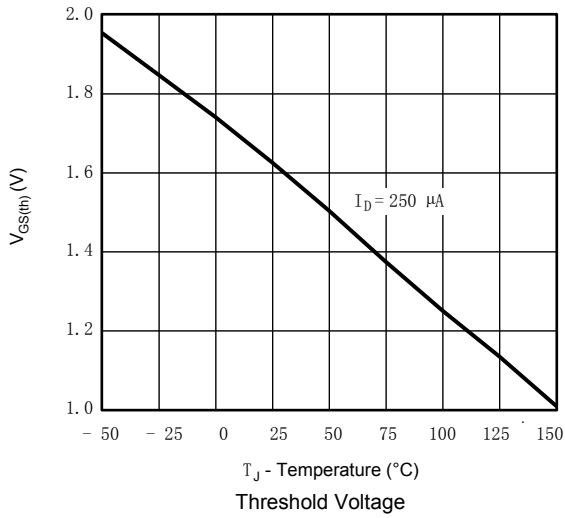
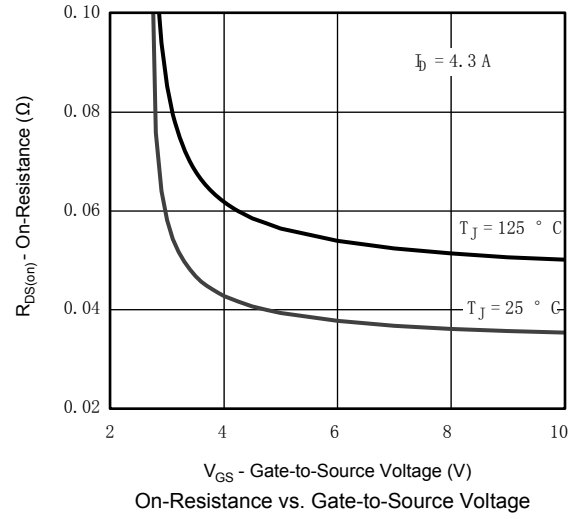
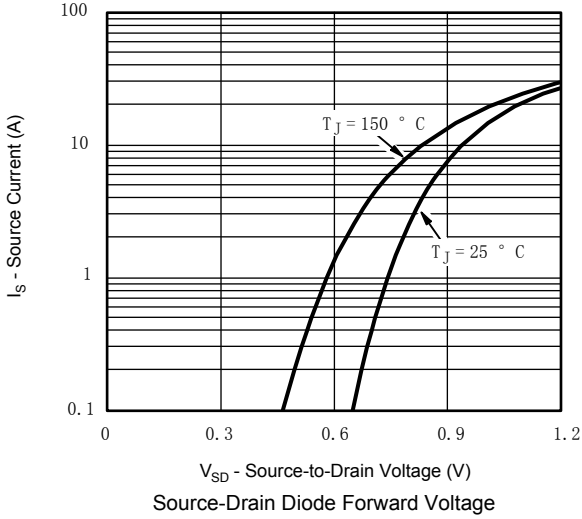

**SOT-23-3L Plastic-Encapsulate MOSFETS**

■ Typical Characteristics

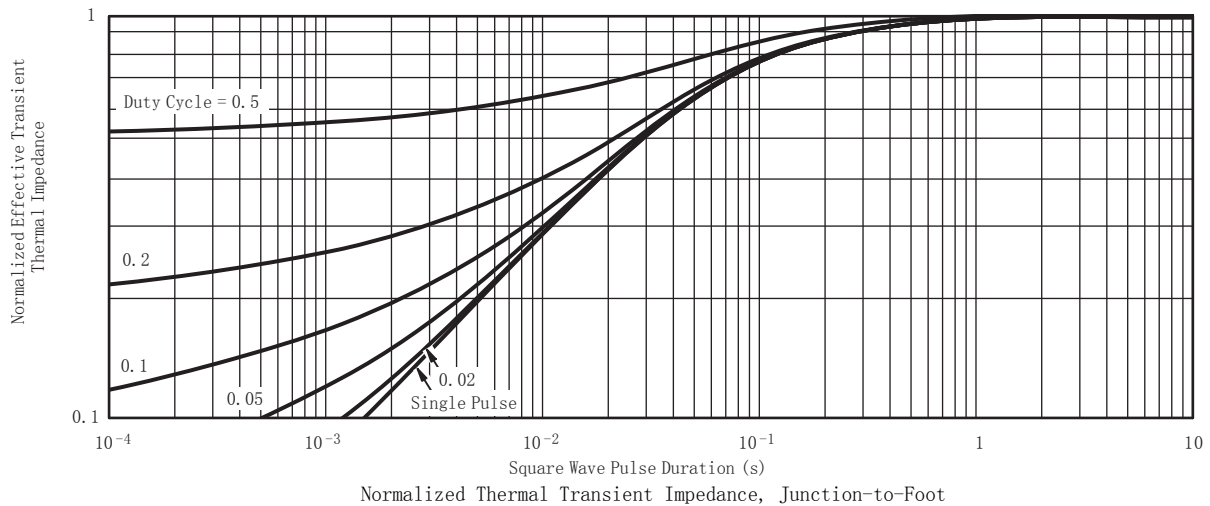
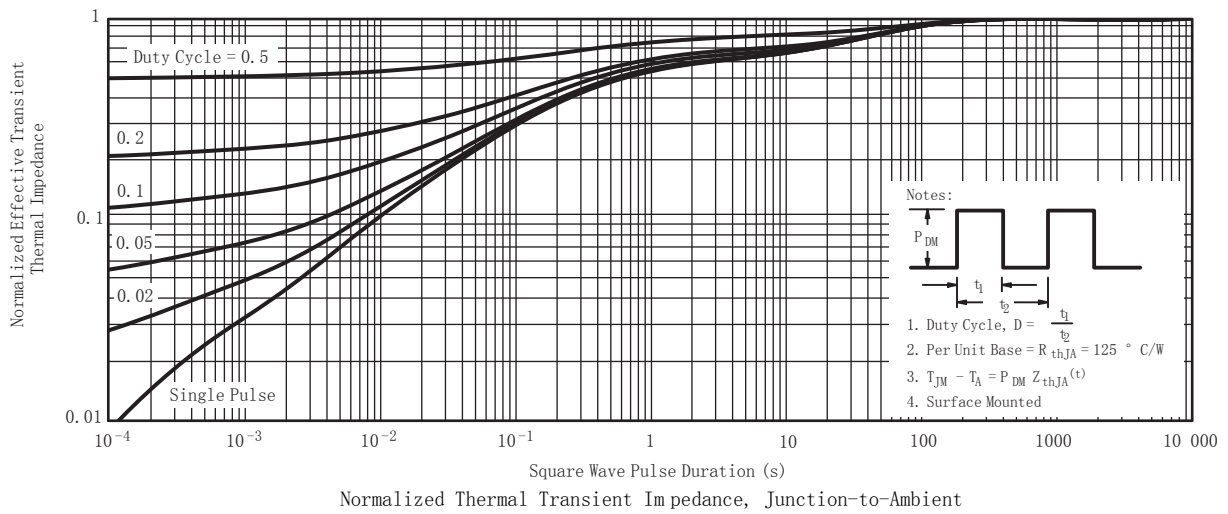
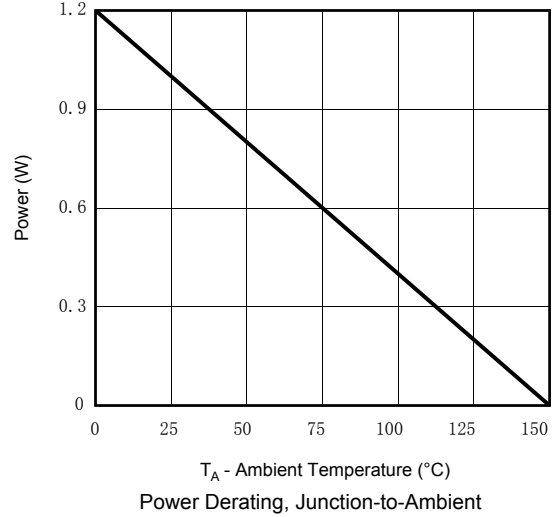
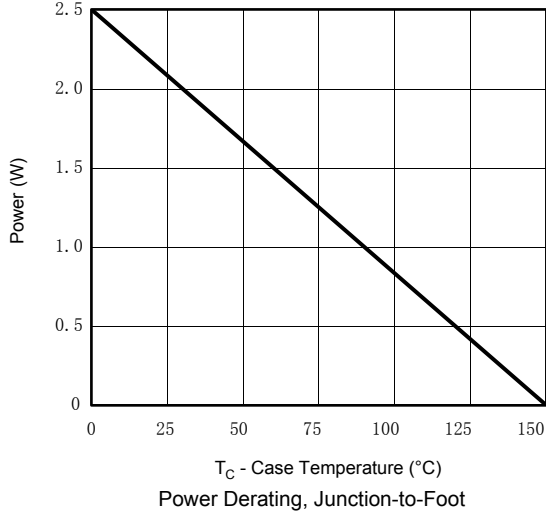

**SOT-23-3L Plastic-Encapsulate MOSFETS**

**SOT-23 PACKAGE OUTLINE DIMENSIONS**

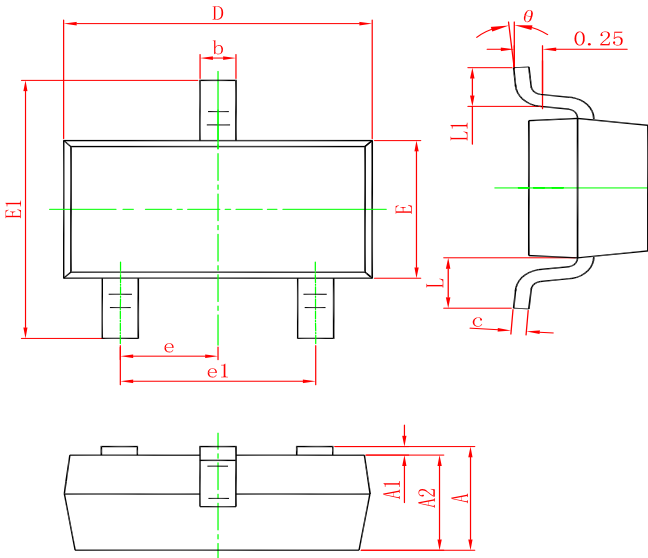

Symbol	Dimensions In Millimeters		Dimensions In Inches	
	Min.	Max.	Min.	Max.
A	0.900	1.150	0.035	0.045
A1	0.000	0.100	0.000	0.004
A2	0.900	1.050	0.035	0.041
b	0.300	0.500	0.012	0.020
c	0.080	0.150	0.003	0.006
D	2.800	3.000	0.110	0.118
E	1.200	1.400	0.047	0.055
E1	2.250	2.550	0.089	0.100
e	0.950 TYP.		0.037 TYP.	
e1	1.800	2.000	0.071	0.079
L	0.550 REF.		0.022 REF.	
L1	0.300	0.500	0.012	0.020
theta	0°	8°	0°	8°

**Marking**

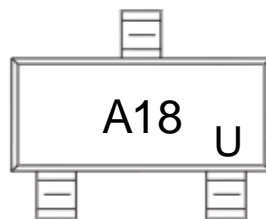

**Ordering information**

Order code	Package	Baseqty	Deliverymode
SI2318A	SOT-23	3000	Tape and reel