

FEATURES

- $V_{DS} (V) = -30V$
- $R_{DS(ON)} < 46m\Omega$ ($V_{GS} = -10V$)
- $R_{DS(ON)} < 54m\Omega$ ($V_{GS} = -4.5V$)

APPLICATIONS

- For Mobile Computing
- Load Switch
- Notebook Adaptor Switch
- DC/DC Converter

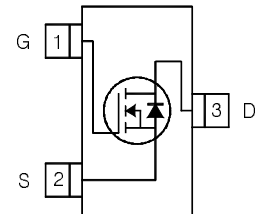
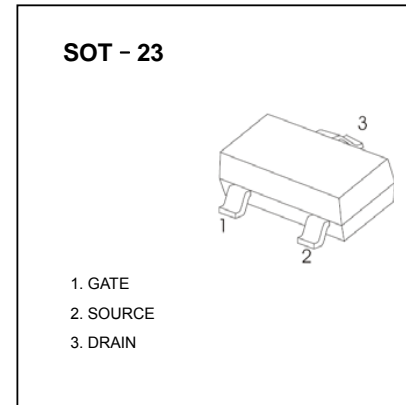

ABSOLUTEMAXIMUM RATINGS ($T_A = 25\text{ }^\circ\text{C}$, unless otherwise noted)

Parameter	Symbol	Limit	Unit
Drain-Source Voltage	V_{DS}	- 30	V
Gate-Source Voltage	V_{GS}	± 20	
Continuous Drain Current ($T_J = 150\text{ }^\circ\text{C}$)	I_D	$T_C = 25\text{ }^\circ\text{C}$	- 5.6
		$T_C = 70\text{ }^\circ\text{C}$	- 5.1
		$T_A = 25\text{ }^\circ\text{C}$	- 5.4 ^{b,c}
		$T_A = 70\text{ }^\circ\text{C}$	- 4.3 ^{b,c}
Pulsed Drain Current ($t = 100\text{ }\mu\text{s}$)	I_{DM}	- 18	A
Continuous Source-Drain Diode Current	I_S	$T_C = 25\text{ }^\circ\text{C}$	
		$T_A = 25\text{ }^\circ\text{C}$	- 1 ^{b,c}
Maximum Power Dissipation	P_D	$T_C = 25\text{ }^\circ\text{C}$	2.5
		$T_C = 70\text{ }^\circ\text{C}$	1.6
		$T_A = 25\text{ }^\circ\text{C}$	1.25 ^{b,c}
		$T_A = 70\text{ }^\circ\text{C}$	0.8 ^{b,c}
Operating Junction and Storage Temperature Range	T_J, T_{stg}	- 55 to 150	$^\circ\text{C}$

THERMAL RESISTANCE RATINGS

Parameter	Symbol	Typical	Maximum	Unit
Maximum Junction-to-Ambient ^{b,d}	R_{thJA}	75	100	$^\circ\text{C/W}$
Maximum Junction-to-Foot (Drain)	R_{thJF}	40	50	

Notes:

- a. Based on $T_C = 25\text{ }^\circ\text{C}$.
- b. Surface mounted on 1" x 1" FR4 board.
- c. $t = 5\text{ s}$.
- d. Maximum under steady state conditions is 166 $^\circ\text{C/W}$.

SPECIFICATIONS ($T_J = 25\text{ }^\circ\text{C}$, unless otherwise noted)

Parameter	Symbol	Test Conditions	Min.	Typ.	Max.	Unit
Static						
Drain-Source Breakdown Voltage	V_{DS}	$V_{GS} = 0\text{ V}, I_D = -250\text{ }\mu\text{A}$	-30			V
V_{DS} Temperature Coefficient	$\Delta V_{DS}/T_J$	$I_D = -250\text{ }\mu\text{A}$		-19		mV/°C
$V_{GS(th)}$ Temperature Coefficient	$\Delta V_{GS(th)}/T_J$		4			
Gate-Source Threshold Voltage	$V_{GS(th)}$	$V_{DS} = V_{GS}, I_D = -250\text{ }\mu\text{A}$	-0.5		-2.0	V
Gate-Source Leakage	I_{GSS}	$V_{DS} = 0\text{ V}, V_{GS} = \pm 20\text{ V}$			± 100	nA
Zero Gate Voltage Drain Current	I_{DSS}	$V_{DS} = -30\text{ V}, V_{GS} = 0\text{ V}$			-1	μA
		$V_{DS} = -30\text{ V}, V_{GS} = 0\text{ V}, T_J = 55\text{ }^\circ\text{C}$			-5	
On-State Drain Current ^a	$I_{D(on)}$	$V_{DS} \leq -5\text{ V}, V_{GS} = -10\text{ V}$	-2.5			A
Drain-Source On-State Resistance ^a	$R_{DS(on)}$	$V_{GS} = -10\text{ V}, I_D = -4.4\text{ A}$		46	55	m Ω
		$V_{GS} = -4.5\text{ V}, I_D = -3.6\text{ A}$		54	63	
Forward Transconductance ^a	g_{fs}	$V_{DS} = -15\text{ V}, I_D = -3.4\text{ A}$		18		S
Dynamic^b						
Input Capacitance	C_{iss}	$V_{DS} = -15\text{ V}, V_{GS} = 0\text{ V}, f = 1\text{ MHz}$		1295		μF
Output Capacitance	C_{oss}		150			
Reverse Transfer Capacitance	C_{rss}		130			
Total Gate Charge	Q_g	$V_{DS} = -15\text{ V}, V_{GS} = -10\text{ V}, I_D = -5.4\text{ A}$		24	36	nC
				11.4	17	
Gate-Source Charge	Q_{gs}	$V_{DS} = -15\text{ V}, V_{GS} = -4.5\text{ V}, I_D = -5.4\text{ A}$		3.4		
Gate-Drain Charge	Q_{gd}		3.8			
Gate Resistance	R_g	$f = 1\text{ MHz}$	1.5	7.7	15.4	Ω
Turn-On Delay Time	$t_{d(on)}$	$V_{DD} = -15\text{ V}, R_L = 3.5\text{ }\Omega$ $I_D \cong -4.3\text{ A}, V_{GEN} = -10\text{ V}, R_g = 1\text{ }\Omega$		13	20	ns
Rise Time	t_r		4	8		
Turn-Off Delay Time	$t_{d(off)}$		38	57		
Fall Time	t_f		6	12		
Turn-On Delay Time	$t_{d(on)}$	$V_{DD} = -15\text{ V}, R_L = 3.5\text{ }\Omega$ $I_D \cong -4.3\text{ A}, V_{GEN} = -4.5\text{ V}, R_g = 1\text{ }\Omega$		28	42	
Rise Time	t_r		16	24		
Turn-Off Delay Time	$t_{d(off)}$		30	45		
Fall Time	t_f		10	20		
Drain-Source Body Diode Characteristics						
Continuous Source-Drain Diode Current	I_S	$T_C = 25\text{ }^\circ\text{C}$			-2.1	A
Pulse Diode Forward Current ($t = 100\text{ }\mu\text{s}$)	I_{SM}				-80	
Body Diode Voltage	V_{SD}	$I_S = -4.3\text{ A}, V_{GS} = 0\text{ V}$		-0.8	-1.2	V
Body Diode Reverse Recovery Time	t_{rr}	$I_F = -4.3\text{ A}, di/dt = 100\text{ A}/\mu\text{s}, T_J = 25\text{ }^\circ\text{C}$		15	23	ns
Body Diode Reverse Recovery Charge	Q_{rr}		7	14	nC	
Reverse Recovery Fall Time	t_a		8		ns	
Reverse Recovery Rise Time	t_b		7			

Notes:

- a. Pulse test; pulse width $\leq 300\text{ }\mu\text{s}$, duty cycle $\leq 2\%$.
b. Guaranteed by design, not subject to production testing.

TYPICAL CHARACTERISTICS (25 °C, unless otherwise noted)

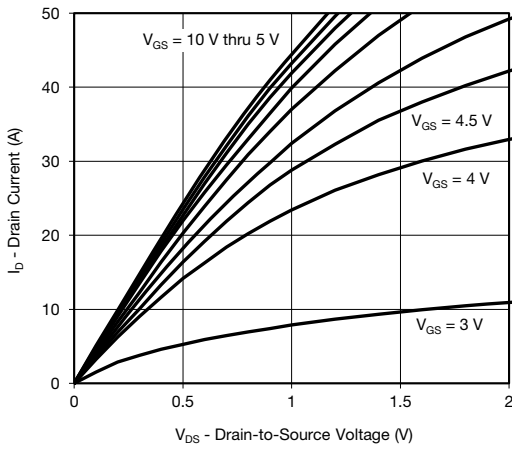

Output Characteristics

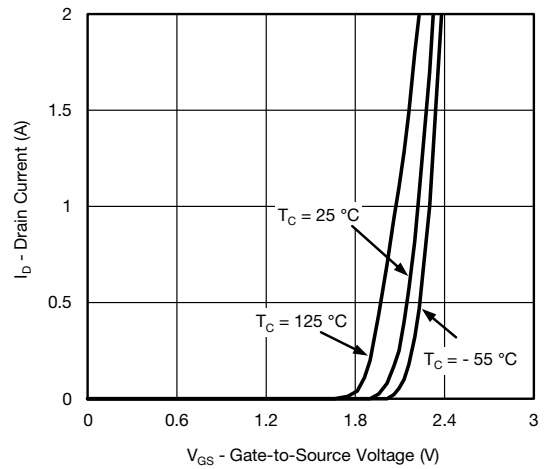

Transfer Characteristics

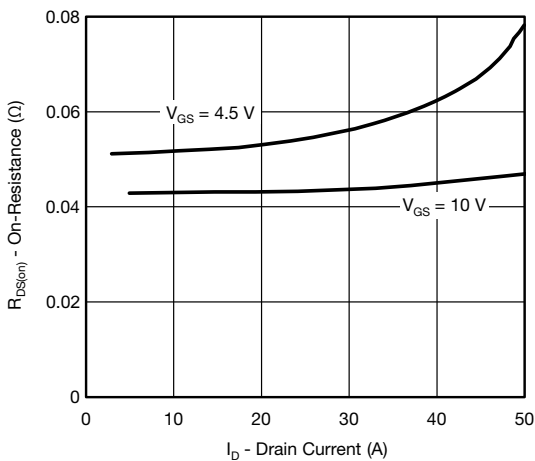

On-Resistance vs. Drain Current

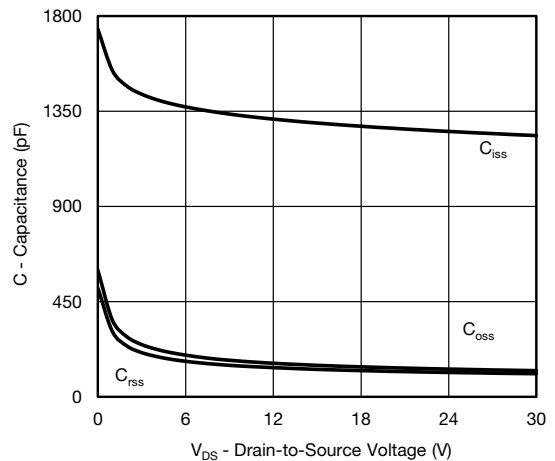

Capacitance

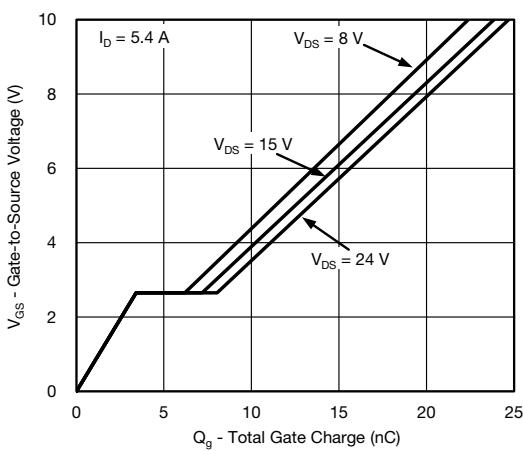

Gate Charge

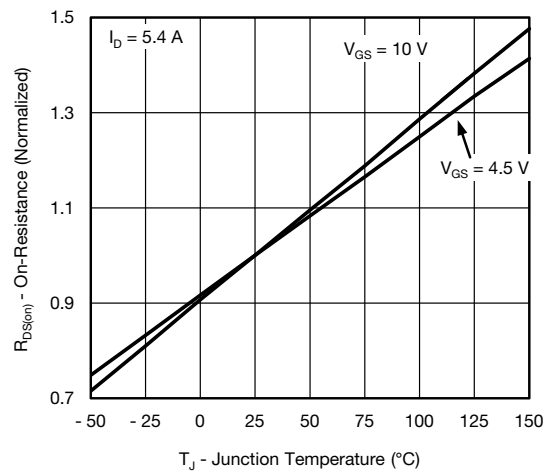

On-Resistance vs. Junction Temperature

TYPICAL CHARACTERISTICS (25 °C, unless otherwise noted)

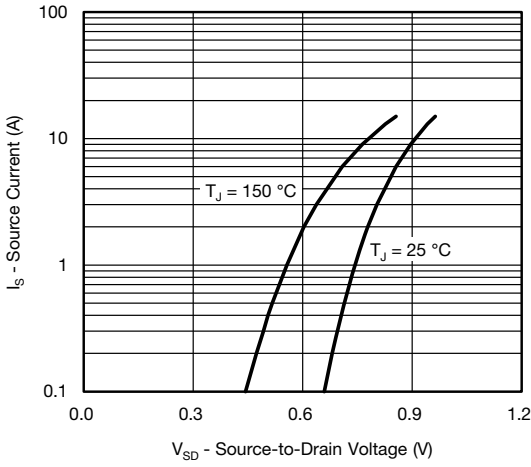

Source-Drain Diode Forward Voltage

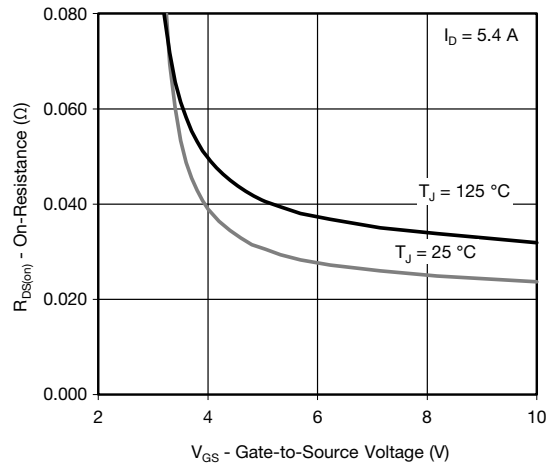

On-Resistance vs. Gate-to-Source Voltage

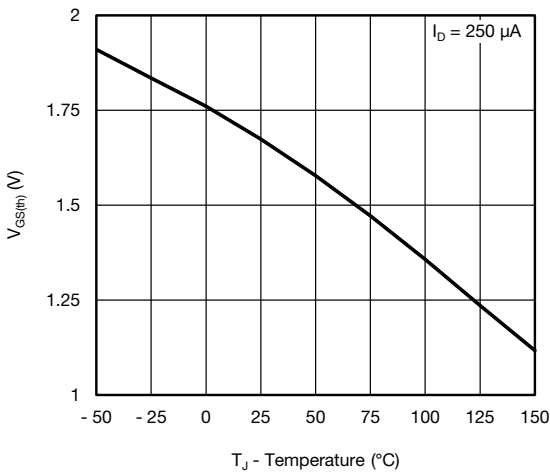

Threshold Voltage

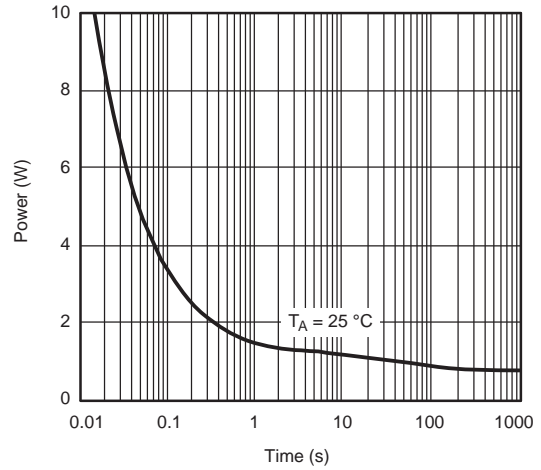

Single Pulse Power (Junction-to-Ambient)

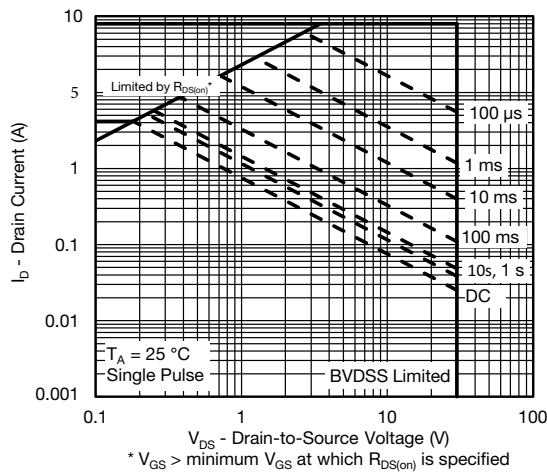

Safe Operating Area, Junction-to-Ambient

TYPICAL CHARACTERISTICS (25 °C, unless otherwise noted)

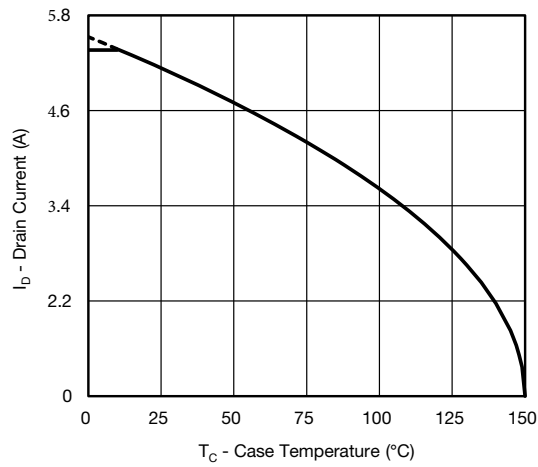

Current Derating*

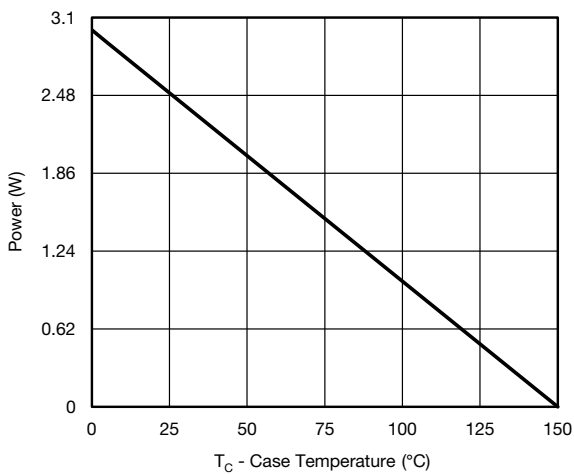

Power, Junction-to-Foot

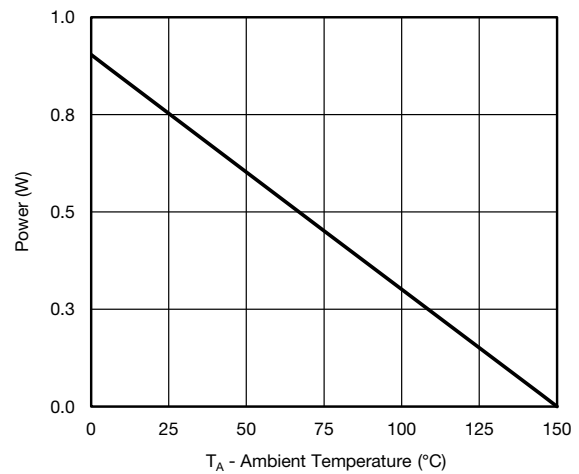

Power, Junction-to-Ambient

* The power dissipation P_D is based on $T_{J(max.)} = 150$ °C, using junction-to-case thermal resistance, and is more useful in settling the upper dissipation limit for cases where additional heatsinking is used. It is used to determine the current rating, when this rating falls below the package limit.

TYPICAL CHARACTERISTICS (25 °C, unless otherwise noted)

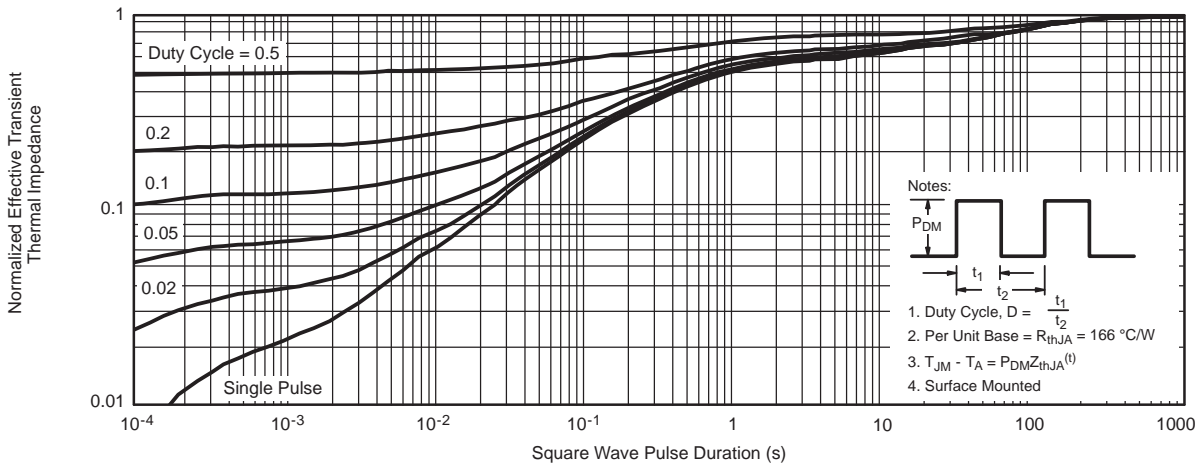

Normalized Thermal Transient Impedance, Junction-to-Ambient

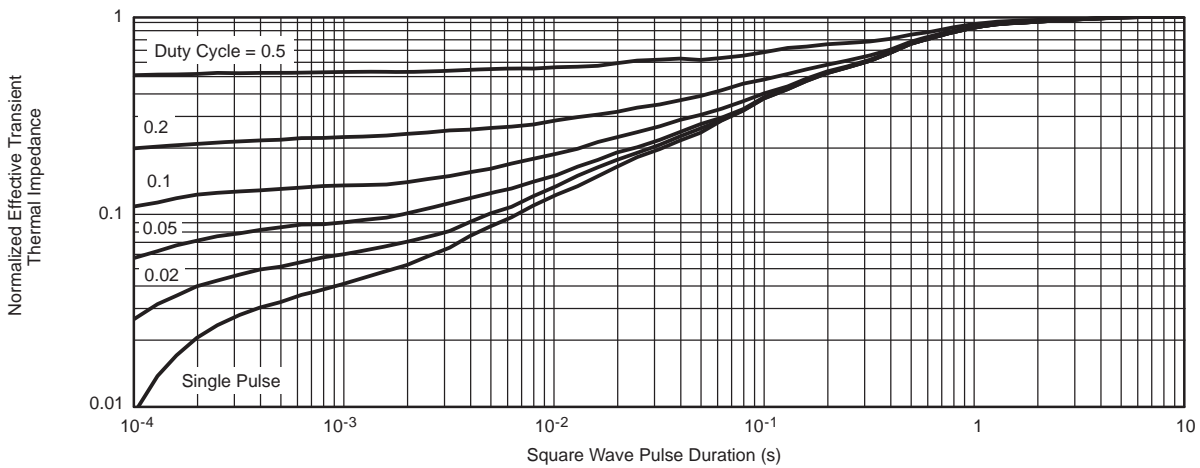

Normalized Thermal Transient Impedance, Junction-to-Foot

SOT-23 PACKAGE OUTLINE DIMENSIONS

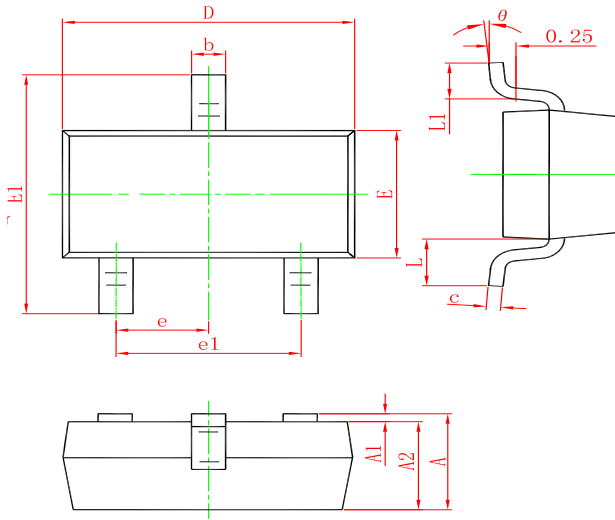

Symbol	Dimensions In Millimeters		Dimensions In Inches	
	Min.	Max.	Min.	Max.
A	0.900	1.150	0.035	0.045
A1	0.000	0.100	0.000	0.004
A2	0.900	1.050	0.035	0.041
b	0.300	0.500	0.012	0.020
c	0.080	0.150	0.003	0.006
D	2.800	3.000	0.110	0.118
E	1.200	1.400	0.047	0.055
E1	2.250	2.550	0.089	0.100
e	0.950 TYP.		0.037 TYP.	
e1	1.800	2.000	0.071	0.079
L	0.550 REF.		0.022 REF.	
L1	0.300	0.500	0.012	0.020
θ	0°	8°	0°	8°

Marking

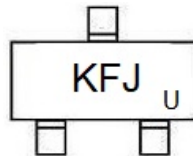

Ordering information

Order code	Package	Baseqty	Deliverymode
SSM3J332R	SOT-23	3000	Tape and reel