

■ **Surface Mount Schottky Barrier Rectifier**

■ **Features**

- Metal silicon junction, majority carrier conduction
- For surface mounted applications
- Low power loss, high efficiency
- High forward surge current capability
- For use in low voltage, high frequency inverters, free wheeling, and polarity protection applications

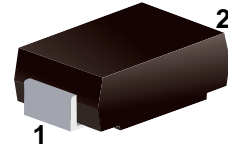

1.Cathode
2.Anode

■ **Simplified outline(SMC)**

Top View ←

■ **Maximum Ratings and Electrical characteristics**

Ratings at 25 °C ambient temperature unless otherwise specified.

Single phase half-wave 60 Hz, resistive or inductive load, for capacitive load current derate by 20 %.

Parameter	Symbols	SS52C	SS54C	SS56C	SS58C	SS510C	SS512C	SS515C	SS520C	Units
Maximum Repetitive Peak Reverse Voltage	V_{RRM}	20	40	60	80	100	120	150	200	V
Maximum RMS voltage	V_{RMS}	14	28	42	56	70	84	105	140	V
Maximum DC Blocking Voltage	V_{DC}	20	40	60	80	100	120	150	200	V
Maximum Average Forward Rectified Current	$I_{F(AV)}$	5.0								A
Peak Forward Surge Current, 8.3ms Single Half Sine-wave Superimposed on Rated Load (JEDEC method)	I_{FSM}	175				150				A
Max Instantaneous Forward Voltage at 5 A	V_F	0.45	0.55	0.70		0.85				V
Maximum DC Reverse Current $T_a = 25^\circ\text{C}$ at Rated DC Reverse Voltage $T_a = 100^\circ\text{C}$	I_R					1.0 50				mA
Typical Junction Capacitance ⁽¹⁾	C_j	600			400					pF
Typical Thermal Resistance ⁽²⁾	$R_{\theta JA}$	35								°C/W
Operating Junction Temperature Range	T_j	-55 ~ +150								°C
Storage Temperature Range	T_{stg}	-55 ~ +150								°C

(1) Measured at 1 MHz and applied reverse voltage of 4 V D.C

(2) P.C.B. mounted with 2.0" X 2.0" (5 X 5 cm) copper pad areas.

Fig.1 Forward Current Derating Curve

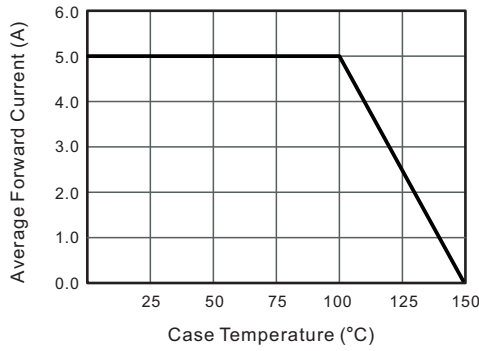

Fig.2 Typical Reverse Characteristics

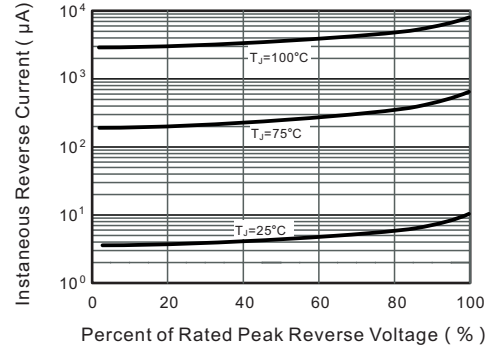

Fig.3 Typical Forward Characteristic

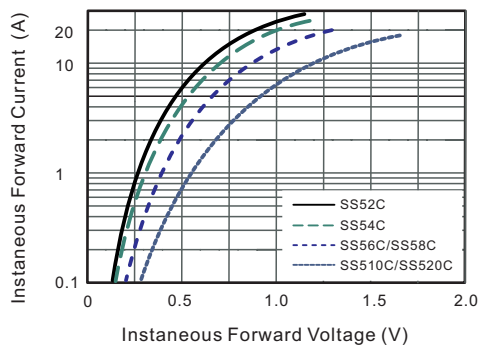

Fig.4 Typical Junction Capacitance

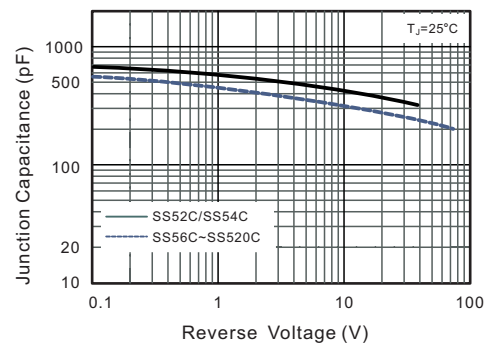

Fig.5 Maximum Non-Repetitive Peak Forward Surge Current

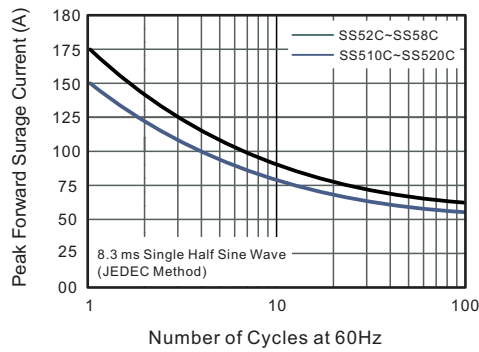
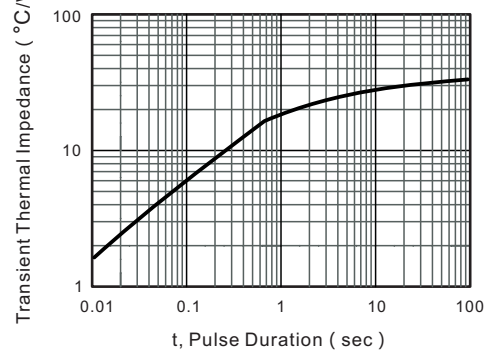
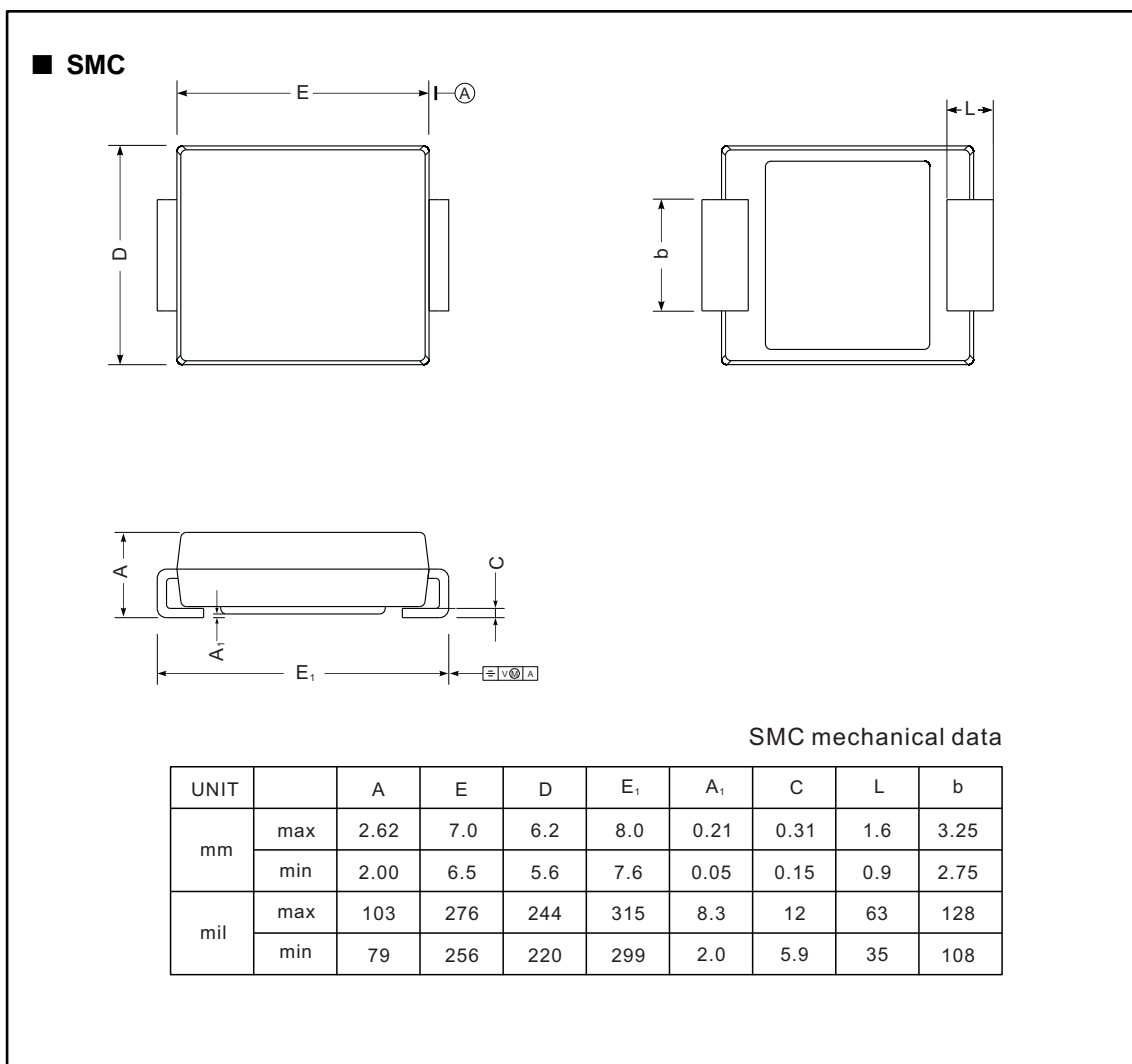

Fig.6- Typical Transient Thermal Impedance





The recommended mounting pad size

